



# IALA GUIDELINE

## G1129 THE RETRANSMISSION OF SBAS CORRECTIONS USING MF-RADIO BEACON AND AIS

**Edition 2.0**

June 2022

**urn:mrn:iala:pub:g1129:ed2.0**



# DOCUMENT REVISION

---

Revisions to this document are to be noted in the table prior to the issue of a revised document.

Date	Details	Approval
December 2017	First issue	Council 65
June 2022	Edition 2.0 Section 5. Edit of section 5 and additional annexes included.	Council 75



# CONTENTS

---

<b>1. INTRODUCTION</b> .....	<b>5</b>
<b>2. SCOPE</b> .....	<b>5</b>
<b>3. SBAS USE IN MARITIME</b> .....	<b>5</b>
3.1. SBAS Signal In Space (SiS) .....	6
3.2. SBAS data used via maritime service providers' AtoN .....	8
<b>4. SBAS DATA USED VIA MARITIME SERVICE PROVIDERS' ATON</b> .....	<b>9</b>
4.1. SBAS over DGNSS messages (IALA Beacon) .....	9
4.1.1. Baseline architecture .....	10
4.1.2. SBAS over DGNSS Trade-Off Analysis .....	11
4.1.3. Hybrid Decentralized Architecture: classical DGNSS + SBAS (SiS or internet) Based .....	14
4.1.4. Hybrid Centralized Architecture: classical DGNSS + SBAS (SiS or internet) Based VRS.....	16
4.1.5. Redundant Fully SBAS Based Solution .....	18
4.2. SBAS over Automatic Identification System (AIS).....	19
4.2.1. Baseline architecture .....	19
4.2.2. SBAS over AIS Trade-off analysis .....	20
4.2.3. Centralized SBAS based DGNSS solution over AIS service .....	22
4.2.4. Decentralized SBAS based DGNSS solution over AIS service .....	24
4.3. SBAS over other data channels under development such as VDES (VHF Data Exchange System) .....	25
<b>5. SBAS BENEFITS AND LIMITATIONS FOR THE SBAS USE VIA ATON</b> .....	<b>26</b>
<b>6. OPERATIONAL ASPECTS</b> .....	<b>27</b>
<b>7. ABBREVIATIONS</b> .....	<b>28</b>
<b>8. REFERENCES</b> .....	<b>29</b>
<b>ANNEX A SBAS BASIC ARCHITECTURES</b> .....	<b>31</b>
<b>ANNEX B SBAS SIS AND MESSAGES</b> .....	<b>32</b>
<b>ANNEX C IDENTIFICATION OF THE DIFFERENT EXISTING SBAS SYSTEMS, COVERAGE AND PERFORMANCES</b> .....	<b>34</b>
<b>ANNEX D SBAS FUTURE DEVELOPMENTS AND TRENDS</b> .....	<b>35</b>
<b>ANNEX E MAPPING OF RTCA SBAS MESSAGES TO RTCM 2. X</b> .....	<b>37</b>
<b>ANNEX F GENERIC COST ANALYSIS FOCUSED ON RELEVANT ARCHITECTURES FOR THE TRANSMISSION OF SBAS CORRECTIONS OVER IALA BEACON AND AIS</b> .....	<b>41</b>
<b>ANNEX G RECOMMENDATIONS</b> .....	<b>52</b>

## List of Tables

<i>Table 1</i>	<i>Maritime Operational Requirements. IMO A.1046 (27)</i> .....	<i>7</i>
<i>Table 2</i>	<i>Key features description and Trade-Off assessment</i> .....	<i>13</i>



# CONTENTS

---

Table 3	Key features and trade off assessment .....	21
Table 4	E.g., SBAS Messages RTCA DO-229D .....	32
Table 5	Derivation of S_DGNSS .....	40
Table 6	Costs variation – 10 stations – infrastructure upgrade .....	46
Table 7	Costs variation – 10 stations – new infrastructure.....	46
Table 8	Costs variation – 20 stations – infrastructure upgrade .....	50
Table 9	Costs variation – 20 stations – New infrastructure .....	51

## List of Figures

Figure 1	Generic view of the SBAS transmission /reception options in the maritime sector .....	6
Figure 2	DGNSS Service Architecture: Classic and Network Approach [4] .....	10
Figure 3	Baseline redundant IALA Architecture.....	10
Figure 4	Hybrid Decentralized Architecture: classical DGNSS + SBAS (SiS or Internet) Based.....	14
Figure 5	Hybrid Centralized Architecture: classical DGNSS + SBAS Based VRS.....	16
Figure 6	Fully SBAS Based Solution.....	19
Figure 7	Functional block diagram of an AIS base station[2].....	20
Figure 8	Classical DGNSS over AIS Centralized solution .....	22
Figure 9	SBAS based DGNSS corrections over AIS architecture .....	23
Figure 10	SBAS based AIS station: RS & IM block diagram .....	25
Figure 11	Basic SBAS Architecture.....	31
Figure 12	SBAS Messages. RTCA DO-229D .....	32
Figure 13	SBAS systems indicative coverage (source EUSPA[10]) .....	34
Figure 14	Availability map of Single Frequency, Single Constellation SBAS .....	35
Figure 15	Frequencies and bandwidths allocated to GPS, GLONASS, and Galileo .....	36
Figure 16	Generic view of 2025 Coverage of Dual Frequency, Multiple Constellation (DFMC) SBAS .....	36

## 1. INTRODUCTION

---

It is recognised that while Global Navigation Satellite Systems (GNSS) have become the primary means of obtaining Position, Navigation and Timing (PNT) information at sea, augmentation is required to ensure the necessary level of integrity is achieved and accuracies improved, over the use of GNSS alone.

While Ground Based Augmentation Systems (GBAS), such as marine radio beacon DGNSS have been in use for some time, recent developments have enabled Satellite Based Augmentation Systems (SBAS) to be considered for maritime use.

There are many SBAS in operation around the world, largely serving the Northern Hemisphere. While originally developed for aviation users, their use in the maritime sector is increasing. This document aims to set out where Marine Aids-to-Navigation service providers could use SBAS within their service provision.

## 2. SCOPE

---

This document sets out guidance for Marine Aids to Navigation (AtoN) service providers wishing to understand where SBAS information could be used to support the mariner and then how to employ such data.

It is expected the mariners will use SBAS direct Signal in Space (SiS) however, the main purpose of the document is to describe the SBAS use within augmentation services via marine radio beacon and AIS transmissions. The document aims to consider common SBAS functionality rather than focus on any specific SBAS system, but does refer to specific SBAS services where required.

The document provides an overview of SBAS structure, use and general coverage areas in section 3. For the sake of completeness, the direct use of SBAS from SiS on-board is introduced in section 3.1 and complementary information is included in different annexes.

Recognising that the generation of differential corrections can be split from the means of transmission, a number of different example architectures are provided in Section 4. These are meant as examples, recognising that the infrastructure deployed, and operational architecture will vary between service providers. Some benefits and limitations of retransmitting SBAS information via AtoNs are given in section 5.

Finally, operational aspects are addressed in section 6.

## 3. SBAS USE IN MARITIME

---

Satellite-Based Augmentation Systems are designed to augment the GNSS by providing correction data and integrity information for improving positioning, navigation, and timing.

GNSS measurements are made at accurately located reference stations, deployed across a wide area. The data from these is then provided to a central processing element, which calculates differential corrections and integrity information for the constellation, or constellations monitored.

This information is then broadcast over the service area using satellites. There are several SBAS services in operation around the world, currently providing regional coverage areas within the northern hemisphere, all of which provide interoperable signals from the various satellites. See annex A for more detailed information about SBAS architecture and annex C for information about the current SBAS systems.

There are different approaches on how SBAS data could be used in the maritime sector (figure 1).

- SBAS Data used from Satellites (Signal in Space);
- SBAS Data used via Maritime Service providers' AtoN.

In the second case, SBAS data can be provided to the mariner over an existing marine radio service currently used for a recognized AtoN, such as marine radio beacon MF (283.5-325 kHz) or VHF frequencies used for AIS.

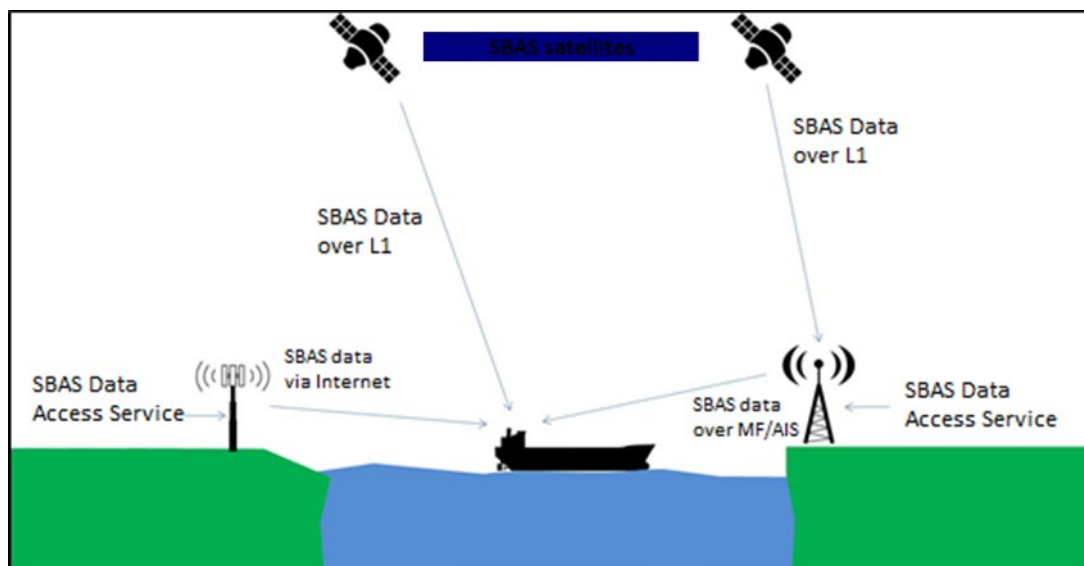

Figure 1 Generic view of the SBAS transmission /reception options in the maritime sector

### 3.1. SBAS SIGNAL IN SPACE (SIS)

The most straightforward solution for the introduction of SBAS in the maritime domain is to use directly the augmentation corrections received from the satellites. Annex B provides more detailed information about the SBAS SiS characteristics and message types.

SBAS SiS is currently available and used by non-SOLAS vessels to improve the GNSS accuracy. As explained below, at the time of publication, there is no receiver equipment performance/test standard published for SBAS in support of SOLAS applications.

The main advantage of SBAS SiS is the availability of an augmentation solution even in areas where DGNS services are not available, not deployed or out of the range of maritime users. In addition, this solution typically has no cost for maritime authorities nor for the final users, as the SBAS service is provided free of any direct user charge. The accuracy performance is similar in average to that indicated in [4] for DGNS (<5m, 95%) with homogenous performances in the SBAS service area in comparison with DGNS where the accuracy performance is higher in the vicinity of the beacon and degrades with the distance.

The administrations seeking to use or recognize SBAS services for maritime applications should consult the SBAS service provider in the area (see ANNEX C) regarding the service performances for maritime/merchant shipping use. The current SBAS systems typically meet the IMO Resolution A.1046 (27) [12] operational requirements<sup>1</sup> for navigation in coastal waters, harbour approach and harbour entrances. The table below summarizes those requirements.

<sup>1</sup> SBAS service based on IMO Res. A.1046 (27): EGNOS Maritime performance, ION GNSS+ 2017 EGNOS Multimodal Performances, Coordinates June 2017



Table 1 Maritime Operational Requirements. IMO A.1046 (27)

Maritime operational requirements on IMO A.1046 (27)						
	Horizontal Accuracy 95%	Signal availability	Service continuity (over 15min)	Position update rate	Integrity warnings <sup>1</sup>	System coverage
Ocean waters	100m	99.8%	-	2s	MSI as soon as practicable	Adequate <sup>2</sup>
Harbour entrances, harbour approaches and coastal waters	10m	99.8%	99.97%	2s	10s	Adequate <sup>2</sup>
<sup>1</sup> Generation of integrity warnings in cases of system malfunctions, non-availability or discontinuities.						
<sup>2</sup> Taking into account the radio frequency environment, the coverage of the system should be adequate to provide position-fixing throughout this phase of navigation.						

However, although SBAS is commonly supported by most of GNSS receivers, there is no maritime standard for the SBAS systems in the maritime segment. As a result, implementation of SBAS currently performed by maritime receiver manufacturers is not standardized. In this regard, IMO MSC 95 adopted in 2015 the Multisystem Receiver Performance Standards, including SBAS. This work was completed with the definition of Guidelines for shipborne PNT (data processing) [31] unit adopted by IMO MSC 98 in 2017 and will be followed by the development of the appropriate IEC Test Specification, using the work being carried out in RTCM:

There are initiatives to define in the medium term (2022-2024) a specific SBAS service, based on the SiS, fully compliant with the operational requirements of the IMO Resolution 1046 [12] with the intention to further evolve towards a service compliant with the IMO Resolution A.915. These include:

1. SBAS IMO WWRNS Recognition

IMO MSC98 stated there is no need to follow a process of recognition for SBAS once the Core constellations are recognized, which is the case of GPS, GLONASS, BEIDOU and Galileo.

2. SBAS Service Provision aspects

European Geostationary Navigation Overlay Service (EGNOS) requirements were consolidated under the European Maritime Radio navigation Forum (EMRF) –Service Provision Working Group.

3. Standardization – SBAS RX Guidelines

Radio Technical Commission for Maritime Services, RTCM Special Committee 104, established a SBAS WG to coordinate a guideline for manufacturers to implement SBAS in shipborne receivers compliant with the IMO Res. 1046 (27)

As of the date of writing this guideline, this SBAS guideline is in draft mode and was used as input for IEC61108 part 7 (see paragraph 5 below) standardization for SBAS receiver equipment to ensure a safe use of SBAS by the maritime community (type-approved receivers).

<http://mycoordinates.org/egnos-multimodal-performance>

[http://www.dke-aerospace.com/index.php?option=com\\_content&view=article&id=190:maritime-applications&catid=27:system-engineering&Itemid=28](http://www.dke-aerospace.com/index.php?option=com_content&view=article&id=190:maritime-applications&catid=27:system-engineering&Itemid=28)



#### 4. Standardization – Multisystem Rx including SBAS.

IMO *MSC.401 (95)*, adopted in 2015, established the performance standards for multi-system, including augmentation. Multi-system shipborne radio navigation receivers installed after 31<sup>st</sup> December 2017 are recommended to cover performance standards not inferior to those specified in the aforementioned resolution.

#### 5. Standardization –SBAS L1 shipborne receiver equipment.

The IEC standardization process to produce a new standard *IEC 61108-7* has already started. The title proposal is “*Maritime navigation and radiocommunication equipment and systems - Global navigation satellite systems (GNSS) – Part 7: Satellite Based Augmentation Systems – Receiver Equipment – Performance requirements and method of testing*”.

The New Work Item Proposal (NWIP) for maritime SBAS receiver was launched in February 2021 starting the international standardization process on the International Electrotechnical Commission Technical Committee (TC) 80. In June 2021, the NWIP was approved by the group and a new Project Team at IEC TC80 was created, PT61108-7, to work on the development of the standard for SBAS L1 maritime equipment. In November 2021 the first working draft, *IEC 61108-7 WD*, was presented at IEC TC80 with the aim of having the Committee Draft, *IEC 61108-7 CD*, in 2022. The standard *IEC 61108-7* is expected to be completed by 2023.

Maritime administrations or AtoN service providers should consider the regulatory requirements as part of the process for implementing SBAS in AtoN augmentation services.

The main benefits for the on-board direct use of SBAS SiS are:

- Improved position accuracy and integrity information (receiver implementation under a standardization process. See above) with respect to GNSS when no other DGNSS service is available
- SBAS Systems are interoperable
- Homogeneous performances over the SBAS service area
- Free of any direct user charge
- Large coverage, including areas not served by other DGNSS beacons

### 3.2. SBAS DATA USED VIA MARITIME SERVICE PROVIDERS’ ATON

The potential use of SBAS as a source for the generation of DGNSS corrections, including the required integrity checks, is described in section 4. The principle behind this solution is to convert the SBAS augmentation message (RTCA format) into RTCM corrections referenced to the locations of interest for maritime users (e.g., beacon locations). For example, transmission to end users can be done through marine radio beacons or AIS base stations (via AIS #17 message), hence ensuring compatibility with the already deployed equipment at user level. Three subcategories are presented in the document:

- Transmission of SBAS derived corrections over DGNSS stations (marine radio beacons)
- Transmission of SBAS derived corrections over AIS stations
- Transmission of SBAS corrections over future VDE data channels (further information in section 4.3)

Regarding the access to the SBAS data, two different options are also considered:

- *SBAS SiS*: The source for the generation of the DGNSS corrections (RTCM 2.x) to be broadcast by the marine radio beacons or AIS is the SBAS Signal in Space.



- *Internet-based SBAS access point:* Some SBAS providers can deliver corrections by internet (e.g., EGNOS Data Access Service (EDAS)). Therefore, this option has been also considered when analysing the SBAS source for the generation of the DGNS corrections (RTCM 2.x) to be broadcast.

## 4. SBAS DATA USED VIA MARITIME SERVICE PROVIDERS' ATON

The analysis and description of the solutions in this section is based on functional and technical aspects. Apart from this, the economic aspects are also addressed in the generic cost analysis included in ANNEX F.

ANNEX E includes an example on how SBAS messages in RTCA format could be mapped into RTCM 2.x format.

### 4.1. SBAS OVER DGNS MESSAGES (IALA BEACON)

IALA DGNS concept employs the principle that the main sources of error in satellite navigation (i.e., satellite clock errors, satellite ephemeris errors, tropospheric and ionospheric delay estimation errors) are highly correlated for two users located relatively close to each other.

Differential GNSS corrections are computed by placing a reference station with a GNSS receiver at a known location, determining corrections to the satellite ranging signals, and broadcasting these corrections to users. Then, since the satellite locations and reference antenna location are known, the ranges can be determined precisely. By comparing these ranges to those obtained from the satellite pseudorange measurements, the pseudorange errors can be accurately estimated and corrections determined. These corrections can then be broadcast to nearby users, who use them to improve their position solutions, removing the bias errors common to the reference station and user receivers. User receiver noise, inter-channel biases, user local effects and potential errors in the antenna surveyed position could limit the corrections accuracy.

The SBAS systems provide corrections to the same errors (i.e., satellite clock and ephemeris errors along with ionospheric delay estimation errors), with one exception: the troposphere. For this error source, SBAS systems do not provide corrections; the conversion process (see ANNEX E) will apply a model to reduce the error in the position due to this effect.

Considering this, the SBAS messages can be used for the generation of local area corrections in RTCM format, supporting the certified maritime user equipment already deployed. This could provide some room for the rationalization of the infrastructure. Additionally, local effects potentially affecting the classical approach (e.g., multipath or antenna position not well surveyed) would not impact the quality of the SBAS-based corrections.

On the other hand, as described in the IALA Guideline *G1112 Performance and Monitoring of DGNS Services in the Frequency Band 283.5 – 325 kHz* [4], marine beacon infrastructure can be considered to fall into two different architectures (figure 2), with either equipment all sited at the broadcast locations (classic approach), or some of the infrastructure centralized with only the transmitting equipment at the broadcast site (network approach).

While this generalization can be made, there will be subtle differences within each installation, depending on the degree of risk associated with communication failure, hardware failure and the cost/time associated with attending the site for maintenance.

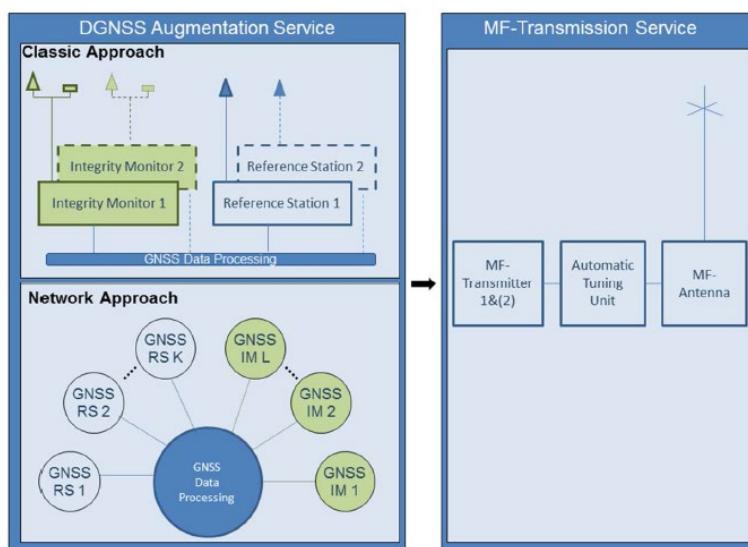

Figure 2 DGNSS Service Architecture: Classic and Network Approach [4]

The information presented hereafter explains the possible functional ways to integrate SBAS data into these architectures. The starting point is the selection of a baseline architecture used as a reference for the analysis. The benefit provided by SBAS on the analysed architectures and their potential drawbacks/limitations, is presented by comparison with respect to classical approach architecture.

#### 4.1.1. BASELINE ARCHITECTURE

This baseline architecture has been defined as a DGNSS service based on the classic approach (IALA Guideline G1112 [4]), including the Reference Station (RS) and the Integrity Monitoring (IM) modules.

It is also noted that this architecture is commonly doubled (two parallel processing streams in figure 3) in order to meet the availability requirements defined by IMO Resolution A.1046 [12].

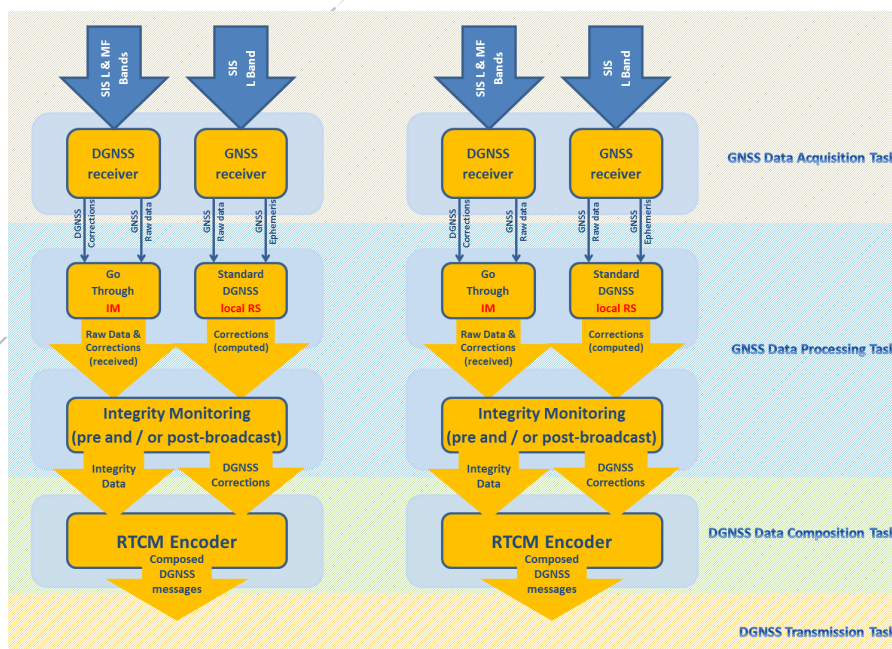

Figure 3 Baseline redundant IALA Architecture

Figure 3 includes a functional representation of the baseline architecture of the Reference Station component that computes the pseudorange corrections based on the GNSS raw data (observations and ephemeris) collected by a GNSS receiver and the surveyed position of the station. These corrections are then encoded in RTCM format and MSK modulated, to be transmitted to the users in the LF/MF band (285 - 325 kHz).

The integrity of the corrections transmitted to the users, is checked by the Integrity Monitor module, which processes the GNSS raw data and the corrections generated by the RS and collected by a DGNS receiver.

This architecture allows both Pre-Broadcast and Post-Broadcast integrity Monitoring concepts. The Post-Broadcast Monitoring concept not only monitors the integrity of the data but also the availability of the radio link and the quality of the signal transmitted. This is one of the major differences with respect to the Pre-Broadcast concept, which includes the integrity monitoring functionality, but does not check the availability of the MF radio link. On the other hand, the Pre-Broadcast approach ensures that all the relevant integrity checks have been performed before DGNS data is transmitted. Service providers can use pre and post broadcast integrity monitoring at the same time.

#### 4.1.2. SBAS OVER DGNS TRADE-OFF ANALYSIS

The three architectures presented in the following sections have been selected based on a trade-off analysis that compares each of the solutions identified [15] for the provision of SBAS-based DGNS corrections via IALA beacons with respect to the baseline architecture described in previous section.

This trade-off analysis takes into account a set of key features (described in Table 2) derived from the baseline architecture and considers the following colour code:

- Green colour: Feature improved w.r.t. the baseline.
- White colour: Same as the baseline (no improvement/degradation)
- Red colour: Feature degraded w.r.t. the baseline.

Among the identified criteria, the following ones are considered mandatory or highly recommended for an SBAS-based architecture:

- **Mandatory (highlighted in bold in the table):** “Legacy on-board receivers compatibility” (LEG) and “Integrity Monitoring” (IM) features.
- **IALA recommendations (highlighted with an asterisk (\*) in the tables):** “MF link monitoring” and “Corrections generation separated from the transmission technology” features [4].

Taking into account this trade-off assessment, three architectures have been selected as the more convenient solutions for the provision of SBAS-based DGNS corrections via IALA beacons:

- Hybrid Decentralized Architecture: classical DGNS + SBAS (SiS or Internet-based SBAS access point) based decentralized
- Hybrid Centralized Architecture: classical DGNS + SBAS (SiS or Internet-based SBAS access point) based centralized
- Redundant Fully SBAS Based Solution

In any case, it should be noted that the assessment of the most convenient architecture for each particular scenario shall be based on a case by case analysis. This analysis shall take into account the topology of the existing IALA DGNS infrastructure (if any) - network or classic approach, the availability of communication lines connecting the different elements comprising the current architecture or the type of GNSS receivers available (SBAS enabled or not), among other technical aspects and also any relevant operational/service requirement provided by the target maritime authority.

The three architectures presented in table 2 (right columns) have been identified as the most beneficial ones among the many different possibilities considered in trade-off assessment [15]. These architectures will be depicted in the following sections. Service providers should note that any other architectures assessed on the trade-off analysis should not be excluded because the assessment may vary depending on their specific implementation scenarios.





Table 2 Key features description and Trade-Off assessment

Key feature used for the assessment	Levels of implementation			Proposed Architectures – Trade Off Assessment		
	Improvement w.r.t. baseline	Baseline	Degraded w.r.t baseline	Hybrid Decentralized	Hybrid Centralized	Redundant Fully SBAS
Infrastructure at site (INF)	Reduced infrastructure	Similar infrastructure. 2 RS + 2 IM (with MF Rx)	Additional infrastructure			
Legacy receivers compatibility (LEG)	N/A	The information broadcast (differential corrections) is compatible with the legacy receivers (RTCM format)	The information broadcast (differential corrections) is NOT compatible with the legacy receivers			
Integrity monitoring (IM)	The architecture includes additional Integrity check	The architecture includes integrity monitoring	The architecture does not include integrity monitoring			
Local effects impact corrections (LOC)	Local errors do not affect the differential corrections	Local errors, such as multipath, receiver noise or masking effects may affect the reference station	N/A			
Type of Communication lines (COM)	No communication lines	Standard communication lines (high-availability communication lines not needed) to connect the RS & IM to the remote CS.	High availability communication lines needed to ensure the IMO availability requirement			
MF link monitoring (MF *)	N/A	The architecture includes the capability of monitoring the MF radio link	The architecture does not include the capability of monitoring the MF radio link			
Redundancy (RED)	Increased redundancy with respect to the baseline architecture	Same redundancy as the baseline architecture (2 RS & 2IM)	Decreased redundancy with respect to the baseline architecture			
Jamming and Spoofing Resiliency (JSR)	In case of jamming attack in the vicinity of the reference station, the DGNSS service will not be affected	In case of jamming attack in the vicinity of the reference station, the DGNSS service will be affected	N/A			
Corrections generation separated from the transmission technology (SEP *)	Yes	No	N/A			

It has to be noted that there are several features for which the assessment depends on the data used in the reference station or the integrity monitoring. For instance, for the “Hybrid Centralized” solution, the assessment of the “Local effects impact corrections” depends on which corrections are finally transmitted to the users: the corrections generated by the decentralized DGNS solution or by the centralized SBAS based architecture. In that case, the corresponding cell has been split to account for the two possible options (see Table 2 above).

The particular details of these three architectures are described in the sections below

#### 4.1.3. HYBRID DECENTRALIZED ARCHITECTURE: CLASSICAL DGNS + SBAS (SiS OR INTERNET) BASED

This is a redundant decentralized solution, combining the classical DGNS configuration (left side in Figure 4) and the SBAS based architecture (right side in Figure 4), which counts on two RS and two IM locally onsite.

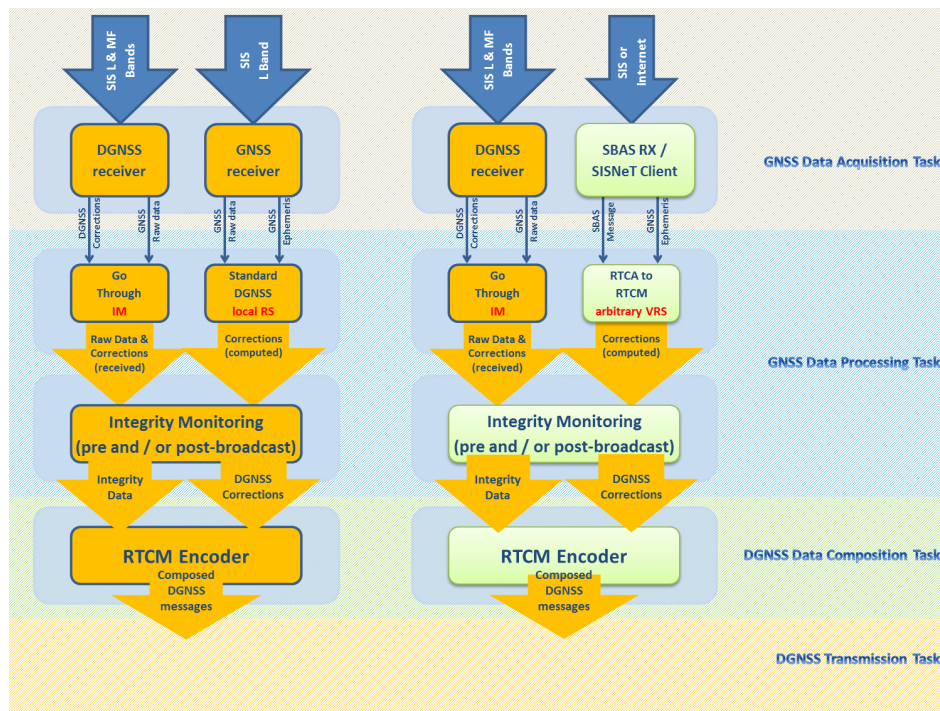

Figure 4 Hybrid Decentralized Architecture: classical DGNS + SBAS (SiS or Internet) Based

The two IM parts (including the IM SW module and the DGNS receiver) are identical in terms of functionality<sup>2</sup> (all inputs/outputs are the same w.r.t the classical architecture):

- Corrections will be in RTCM format in any case, accessed after broadcast by the transmitter (post-broadcast integrity monitoring) or from the corresponding RSIM message delivered by the RS (pre-broadcast).
- The feedback to be sent to the RS is not modified. If the post-broadcast integrity monitoring concept is used, the IM will need to have a DGNS receiver to access the GNSS measurements from the satellites.

In the SBAS-based chain the GNSS receiver and the standard reference station are replaced by a SBAS enabled receiver and a RTCA to RTCM converter. All the components highlighted in the figure 4 (SBAS receiver, RTCA to RTCM converter, Integrity Monitoring and RTCM encoder) could be integrated in a single SW module. This module would be responsible for:

<sup>2</sup> In order to ensure interoperability with commercial the Integrity Monitoring module and the Control Station, the SBAS module should be compliant with RSIM standard

- Getting the SBAS corrections and GNSS ephemeris from the SBAS SiS.
- Converting the SBAS messages into DGNSS corrections in RTCM format.
- Checking the integrity of these corrections (pre and/or post broadcast) based on the information provided by the DGNSS receiver.
- Encoding the differential corrections together with the integrity data in RTCM format.

In order to reduce the infrastructure needed at each beacon site (maintaining redundant Integrity Monitoring architecture), the raw data collected by the GNSS receiver and/or the DGNSS receiver of the classical architecture (left chain in the figure) could be used by the integrity monitoring module of the SBAS based solution (right chain).

A variant for this architecture is to replace the SBAS SiS enabled receiver by a network client if corrections are available also via Internet-based SBAS access point (e.g., *EGNOS*, *EDAS*, *SISNeT client*<sup>3</sup>). In that case, internet connectivity will be needed in the reference station..

Regarding the trade-off assessment presented in Table 2, the analysis of the key features improved by the SBAS-based chain with respect to the baseline architecture is hereafter detailed:

- *Local effects impact:* As detailed in section 5, the fact that the GNSS raw observations are not used for the corrections generation implies that any local effect such as multipath, receiver clock jump/offset or masking effects would not affect the quality of the SBAS-based corrections.
- *Jamming and Spoofing Resilience:* In case of getting the SBAS message and GPS ephemerids from the Internet-based SBAS access point, an eventual jamming attack near the RS would have no impact on the SBAS-based corrections generation.

However, it is noted that depending on the location of the GNSS receivers used for the integrity check, the IM module may be also affected and therefore the SBAS-based solution as well.

---

<sup>3</sup> It should be noted that, when connecting to EDAS SISNeT service, it is needed to choose between the two operational EGNOS GEO satellites. Hence, in order to not penalize the availability of the GPS corrections with respect to the option based on the access to the SBAS messages through the SiS (SBAS compatible receiver is capable of tracking multiple GEOs), two EDAS SISNeT clients shall be used, each of them connected continuously to one EGNOS GEO satellite. Then, the SW to convert from RTCA to RTCM should include a GEO switch function

#### 4.1.4. HYBRID CENTRALIZED ARCHITECTURE: CLASSICAL DGNSS + SBAS (SIS OR INTERNET) BASED VRS

This solution (see Figure 5) combines a classical DGNSS station deployed at each beacon site with a centralized SBAS based VRS solution.

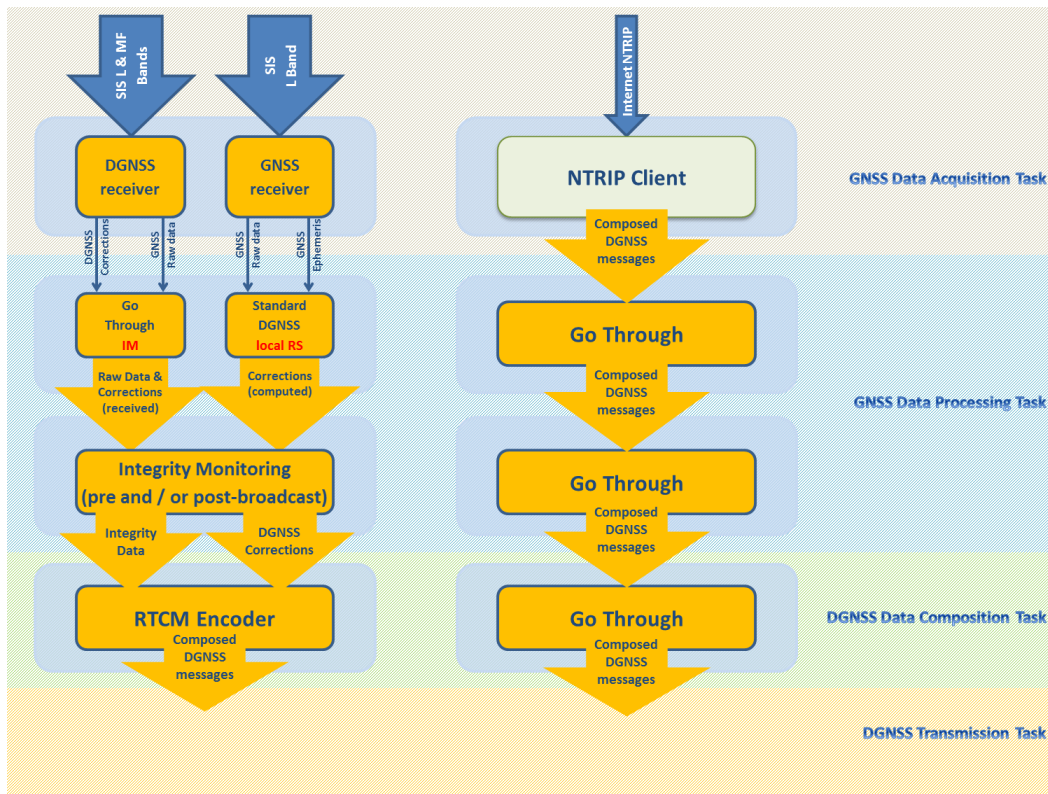

Figure 5 Hybrid Centralized Architecture: classical DGNSS + SBAS Based VRS<sup>4</sup>

For the SBAS-based VRS solution (right chain), both the RS and the IM stations are centralized in the “Central Facility”, and therefore, the only infrastructure needed at each beacon site is the communication lines, client to get the corrections (e.g., NTRIP) and the transmission equipment. On the other hand, it is noted that the network approach results in high requirements concerning the availability and quality of the communication links (IALA Guideline 1112).

The Central Facility computes the Pseudorange Corrections for all the satellites above the elevation mask on the place of the VRS. PRCs and ancillary information (e.g., antenna location) are encoded into RTCM 10402.3 [6] and transmitted to each beacon transmitter site. This Central facility is composed of the following modules:

- **SBAS enabled Receiver:** Providing access to the SBAS satellites correction messages transmitted including GNSS navigation data required for the RTCA to RTCM conversion and GNSS ephemeris.

The main functionality of this module is to implement a real-time interface for the reception of this data on a second by second basis, and to provide the SBAS message in RTCA format and the ephemeris to be injected to the PRC estimator module.

It is recommended to install at least two receivers at two different locations to mitigate the impact of any interference or jamming attack near the receiver.

<sup>4</sup> “Go Through” module: means that no change on the data is done on this layer at the broadcast site. For instance, in the centralised solution, corrections (including integrity) are received at the broadcast site, being only necessary to transmit this data via radio. Hence, no action is done in the “GNSS data processing and composition” tasks.



In case of the European EGNOS service, it is also possible to use a *SISNeT client* to access the SBAS augmentation message (this solution would be resilience to local interferences). The SISNeT protocol, not only allows the users to receive on real-time the EGNOS message through internet but also the GPS navigation data, required for the RTCA to RTCM conversion. Two SISNeT clients shall be used, each of them connected continuously to one EGNOS GEO satellite. Then, the SW to convert from RTCA to RTCM should include a GEO switch function.

- *PRC Estimator*: The primary function of the PRC estimator is to compute the Pseudorange Corrections for satellites above the elevation mask angle for each Virtual Reference Station (VRS). In order to compute these corrections, the PRC Estimator uses as input the following information:
  - Beacons location: This could be obtained from a configuration file, containing the antenna position (WGS-84 datum) for each VRS location;
  - GNSS Navigation message: GNSS ephemeris are provided by the SBAS receiver or GPS in case of EGNOS SISNeT client. They are used to perform the RTCA to RTCM conversion;
  - SBAS corrections in RTCA format.

Then the SBAS-based DGNSS corrections (including SBAS integrity alerts) are then transmitted to the Integrity Checker module.

- *The Integrity Checker*: implements the classical *pre-broadcast integrity* concept by applying the SBAS-based DGNSS corrections to the GNSS raw data collected by the Integrity Monitoring network. This network could be a dedicated/proprietary one (set of receivers specifically deployed within the coverage area) or a GNSS networks provided by an external entity (public or private), independent from the generation of corrections

Therefore, the Central Facility shall implement a module responsible for retrieving the GNSS data from the network of receivers located along the area of service. The main tasks of this module are:

- To manage the communication with the different receivers;
- To select an available GNSS receiver within the coverage range of each beacon transmitter. In case of failure of one of these receivers, this module shall be able to switch to another receiver within the coverage range;
- To process the information collected (GNSS measurements) from the receivers and distribute this data to the Integrity Checker module.

The Integrity Checker, using as input the SBAS-based DGNSS corrections, the raw data collected by the Monitoring Network and known information (e.g., surveyed receiver position), checks the integrity of the corrections both at the Position and the Pseudorange domains.

- *RTCM Encoder*: finally, the SBAS-based DGNSS corrections computed by the PRC estimator along with the integrity flags set by the Integrity Checker are provided to the 'RTCM encoder' module, responsible for encoding all this information in RTCM 10402.3 format

The SBAS-based centralized solution is based on the pre-broadcast monitoring approach, using the raw data collected by a network of GNSS receivers to check the integrity of the generated corrections and a network of MF receivers, to monitor the radio link availability and the quality of the signal transmitted. For a post-broadcast check, far-field integrity remote monitoring stations could be used.

The DGNSS and GNSS receivers in the classical DGNSS architecture (left chain in figure above) could be also used to monitor the signal and corrections transmitted by the SBAS based solution (right chain in the figure below).

Apart from the reduction of HW/SW components of the SBAS based centralized solution at each beacon site, another advantage of this solution is that it is resilient in front of jamming attacks in the vicinity of the reference station. In that situation, the classical reference station will not be able to collect GNSS raw data and therefore not able to generate differential corrections. However, the SBAS based VRS solution will not be affected by this event.

Summarising, the assessment of the key features highlighted in green in Table 2 (improvement with respect to the baseline architecture) is detailed hereafter:

- *Infrastructure reduction.* As mentioned before, no RS neither IM is needed at each beacon for the SBAS-based VRS solution (right chain). Being possible therefore to reduce the HW and SW components needed at each station, with the corresponding benefits in terms of deployment cost, power consumption, maintenance cost or operational procedures
- *Local effects & Multipath.* Refer to the comments provided in previous section
- *Jamming and Spoofing Resilience.* Considering that the SBAS-based corrections are generated, and integrity checked in a central facility (not at each station), an eventual jamming or spoofing attack in the vicinity of the beacon site would have no impact on the service (the classical approach chain – left side – would be affected but there will be no impact on the SBAS-based centralized solution – right chain).
- *Corrections generation separated from the transmission technology.* Apart from the local effects and jamming resilience benefits detailed above, the fact that the corrections are separated from the transmission means also has other benefits such as the flexibility of providing the computed corrections via different means. For instance, the SBAS-based centralized solution can be used to feed not only IALA beacons but also AIS stations as described in section 4.2.

#### 4.1.5. REDUNDANT FULLY SBAS BASED SOLUTION

This is a fully SBAS based solution (figure 6), combining the decentralized (left chain) and centralized (right chain) approaches.

The centralized solution corresponds to the architecture presented in the previous section (right chain), where the RS and the IM stations are centralized in the “Central Facility”. For the decentralized solution (left chain), it is noted that the SBAS corrections can be obtained from an SBAS enabled receiver or from Internet-based SBAS access point (e.g., EDAS, SISNeT service).

The raw data collected by the GNSS receiver and/or the DGNSS receiver of the decentralized architecture (left chain in the figure 6) could be used by the integrity monitoring module of the SBAS based centralized solution (right chain).

Regarding the assessment of the key features improved with respect to the baseline architecture (highlighted in green in Table 2), the same comments provided for the Hybrid Centralized Architecture (see section 4.1.3) are also applicable to this architecture, with the only difference that local effects would neither affect the decentralized chain (left side in Figure 6)

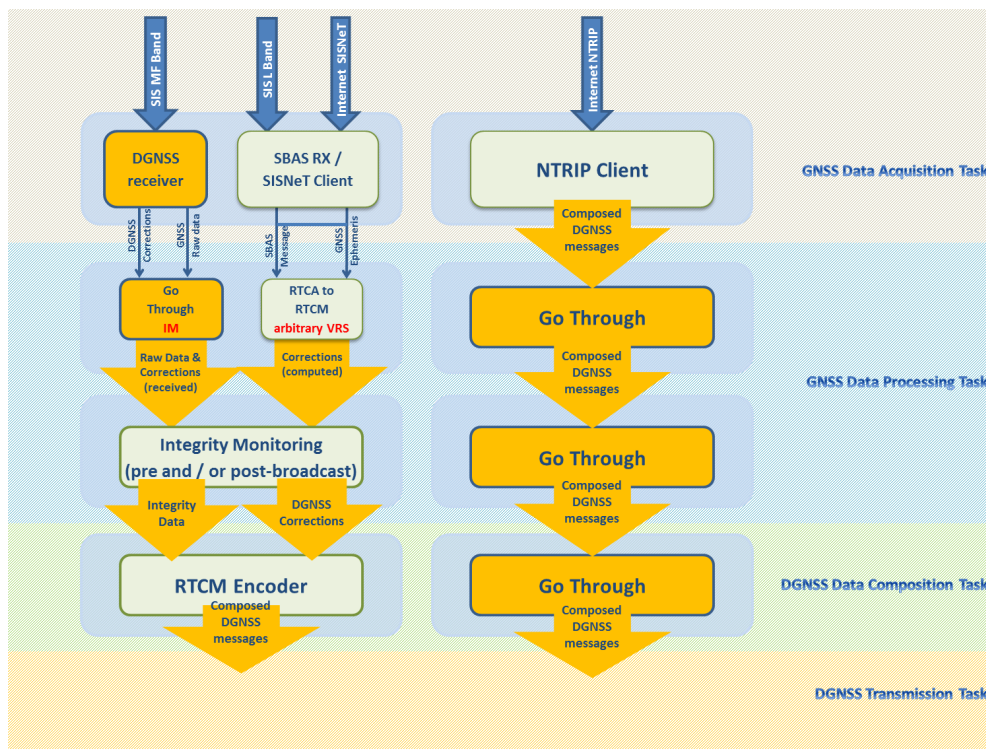

Figure 6 Fully SBAS Based Solution

## 4.2. SBAS OVER AUTOMATIC IDENTIFICATION SYSTEM (AIS)

The provision of DGNS corrections is an optional functionality of the AIS system transmitted through the AIS Message 17 [33]. The estimated load for the transmission of SBAS corrections is less than 1% of VDL capacity [2][32].

The present section provides a high level description of the architectures that could be used to generate DGNS corrections from the SBAS message, obtained from SIS and/or from Internet-based SBAS access point (e.g., EGNOS EDAS), and broadcast them over AIS base stations (using AIS VDL AIS Message 17).

Two different solutions are analysed for the generation of differential GNSS corrections to be transmitted by AIS base stations, depending on the existing AIS service architecture:

- SBAS based DGNS solution over decentralized AIS service (based on the use, locally at the AIS station of the SBAS corrections accessed through the SIS or Internet-based SBAS access point)
- SBAS based DGNS solution over centralized AIS service (for the generation of virtual corrections for each AIS base station in a central facility).

It is to be noted that the integrity monitoring check is recommended for the transmission of DGNS corrections via AIS [2]. In case the DGNS corrections are obtained from an IALA Beacon, the integrity of the corrections is already checked by the reference station. However, in case a dedicated station is deployed, local integrity monitoring is required [1].

### 4.2.1. BASELINE ARCHITECTURE

For a better understanding of the added value of the SBAS based solutions considered and of their potential drawbacks/limitations, a comparison with respect to an arbitrary baseline architecture, where SBAS is not used, was done.

The arbitrary baseline architecture for the provision of DGNS corrections over AIS has been defined as an AIS service getting the pseudorange corrections in RTCM format (including integrity) from a classical DGNS

reference station. It is also assumed that standard communication lines are available at the AIS base station. This baseline has been selected under the understanding that it is the typical (or one of the most common) set-up used today to provide DGNS corrections over AIS (figure 7).

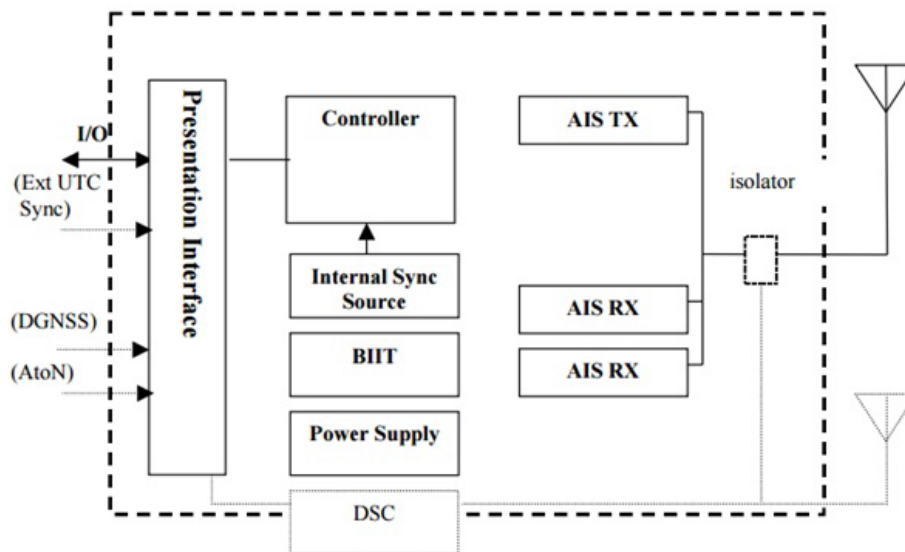

Figure 7 Functional block diagram of an AIS base station[2]

#### 4.2.2. SBAS OVER AIS TRADE-OFF ANALYSIS

The two architectures presented in the following sections have been selected based on a trade-off analysis that compares each of the solutions identified [15] for the provision of SBAS-based DGNS corrections via AIS-base stations with respect to the baseline architecture described in previous section.

This trade-off analysis takes into account a set of key features (described in Table 3) derived from the baseline architecture and considers the following colour code:

- Green colour: Feature improved w.r.t. the baseline.
- White colour: Same as the baseline (no improvement/degradation).
- Red colour: Feature degraded w.r.t. the baseline.

It should be noted that all the architectures analysed [15] provide integrity monitoring. For that reason, the “integrity monitoring” capability has not been included in the trade-off analysis, since there is no difference among the architectures addressed.

Based on the analysis of the key features presented before, among the solutions analysed [15] the most convenient architectures are:

- SBAS based DGNS solution over centralized AIS service.
- SBAS based DGNS solution over decentralized AIS service.

It should be noted that the best alternative to be selected for each case would depend on the type of service provided and on the operational scenario under analysis (infrastructure deployed, operational requirements, service performance requirements, topology of the deployed AIS service, etc).

For the SBAS based decentralized solution the assessment of the communication lines (COM) and resilience to jamming and spoofing (JSR) depends on the source used for the correction data (SBAS SIS or Internet-based SBAS access point). For instance, in case of getting the SBAS data from the SIS, high availability communication lines are not needed but the solution is not robust in front of jamming attacks. For that reason, the corresponding cells have been split to account for these two different options.

The particular details of these two architectures are described in the sections below.



Table 3 Key features and trade off assessment

Key feature used for the assessment	Levels of implementation			Proposed Architectures – Trade Off Assessment	
	Improvement w.r.t. baseline	Baseline	Degraded w.r.t baseline	SBAS Centralized	SBAS Decentralize
Infrastructure at site (INF)	Reduced infrastructure	1 RS + 1 IM (external to the AIS Base Station)	Additional infrastructure		
Local effects impact corrections (LOC)	Local errors do not affect the differential corrections	Local errors, such as multipath, receiver noise or masking effects may affect the reference station	N/A		
Type of Communication lines (COM)	No communication lines	Standard communication lines (high-availability communication lines not needed)	High availability communication lines needed to ensure the IMO availability requirement		
VDL Monitoring (VDL)	The architecture includes the capability of monitoring the VDL radio link	The architecture does not include the capability of monitoring the VDL radio link	N/A		
Redundancy (RED)	There is redundancy at the RS or IM	There is no redundancy at the RS or IM	N/A		
Jamming and Spoofing Resiliency (JSR)	In case of jamming attack in the vicinity of the reference station, the DGNSS service will not be affected	In case of jamming attack in the vicinity of the reference station, the DGNSS service will be affected	N/A		
Customized corrections for each AIS Base Station (CUS)	Differential corrections are customized and generated for each AIS Base station	The same differential corrections are provided by several AIS Base stations	N/A		
Access to internal data (GNSS raw data or signal parameters) from the base or mobile station needed (INT)	N/A	No	Yes		

### 4.2.3. CENTRALIZED SBAS BASED DGNSS SOLUTION OVER AIS SERVICE

This solution consists of generating the AIS Message 17 in a central facility and distributes it to the different AIS base stations.

As depicted in the following figure 8, the RTCM DGNSS correction data from the reference station(s) is encapsulated in an IEC 61162 VDM sentence by the AIS Logical Shore Station (LSS) for processing by the AIS Physical Shore Station Controlling Unit (AIS-PCU). The AIS Message 17 generated by the AIS-PCU is then provided to each base station and finally transmitted to the users through the VDL channel.

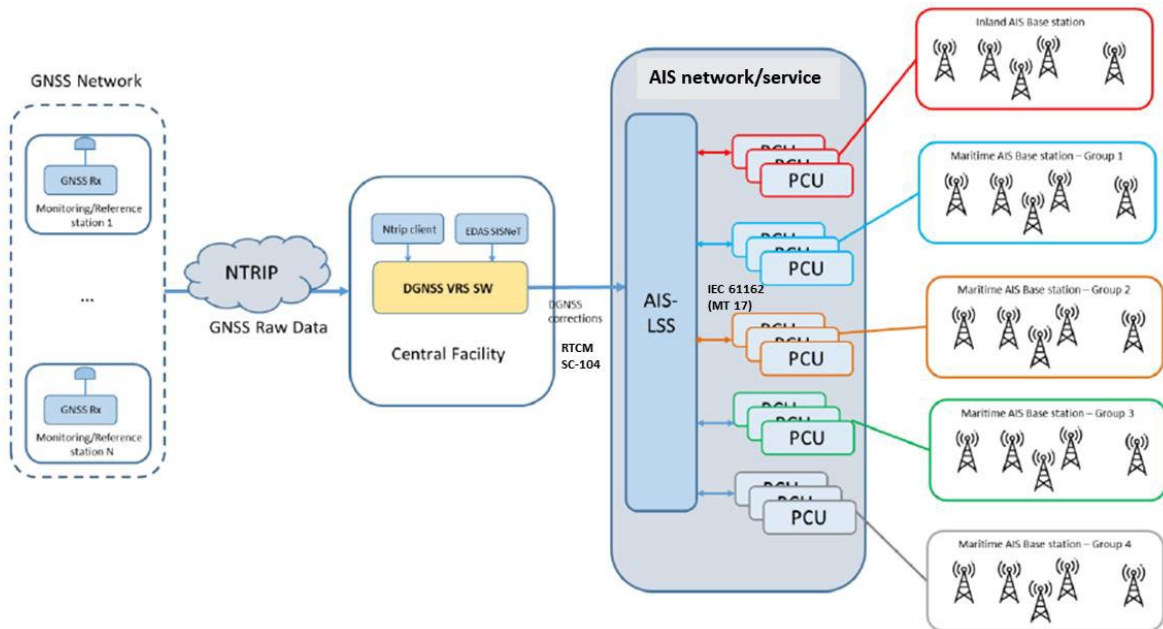

Figure 8 Classical DGNSS over AIS Centralized solution

Considering the short coverage of the AIS base stations (within Line of Sight range), a set of base stations is normally distributed alongside rivers, canals, coast and ports to cover the whole service area. On the other hand, taking into account that the range of a DGNSS station is in the order of 200 NM, the corrections generated by a reference station are normally used to feed multiple AIS base stations. This means that the same DGNSS corrections are transmitted by several AIS base stations.

By contrast, the SBAS corrections in RTCA format can be customized and converted into RTCM format for any location placed within the SBAS service area. Therefore, it is possible to generate RTCM data streams customized for each AIS base station and therefore provide DGNSS corrections for short baseline lengths.

In this way, the accuracy performance could be improved in comparison with the classical approach, in which the corrections generated by a reference station are used to feed multiple stations and therefore, the distance between the rover and the reference station (where the corrections are generated) can be much larger.

At very high level, the architecture of this solution would consist in:

1. *Central Facility (CF)*, responsible for the generation of the RTCM corrections (including integrity).
2. *Monitoring Network*, providing GNSS data for the integrity monitoring check.
3. *AIS network*, which retrieves the SBAS based DGNSS corrections in RTCM format and converts them in an IEC 61162 VDM sentence (discarding the preamble and parity fields) to be then distributed to the final users by the AIS base stations using the VDL channel.

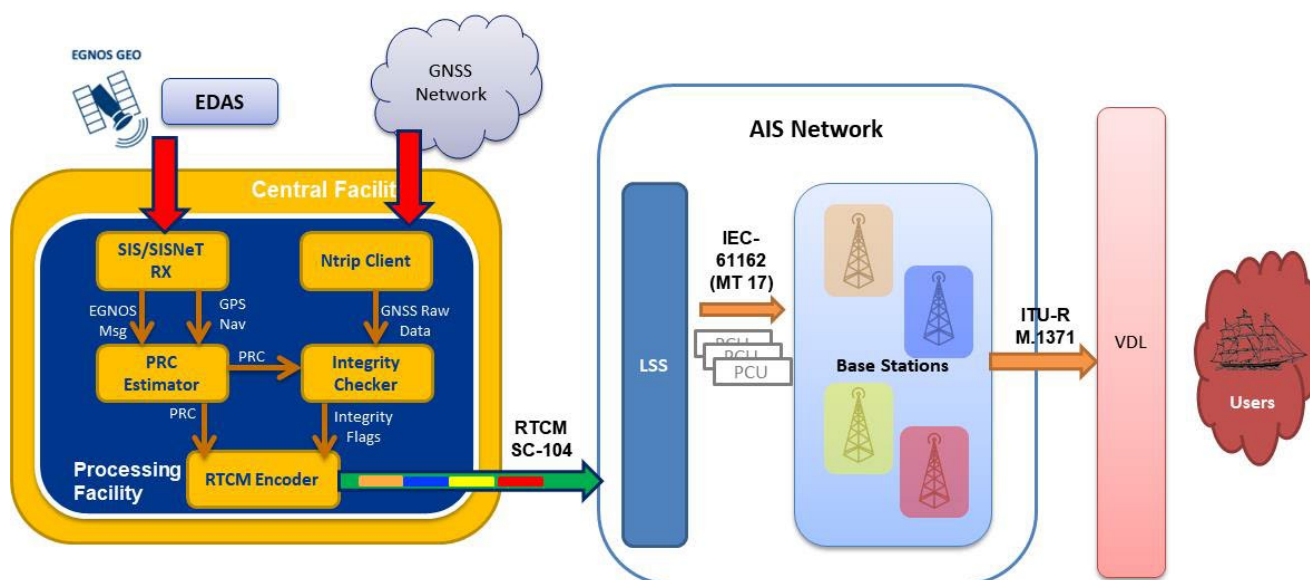

Figure 9 SBAS based DGNSS corrections over AIS architecture

A more detailed description of each of these components is provided below:

- *Central Facility*

The Central Facility is the main component of a centralized SBAS based DGNSS service. The primary function of the Central Facility is to compute the Pseudorange Corrections (PRC) for all the satellites above the elevation mask. PRCs and ancillary information (e.g., antenna location) are encoded into RTCM 10402.3 and transmitted to each beacon transmitter site.

The source for the generation of the DGNSS corrections to be broadcast by the transmitter could be the SBAS Signal in Space or the SBAS messages received from Internet-based SBAS access point.

- *Monitoring Network*

For the integrity monitoring check, the Central Facility needs to have access to GNSS measurements collected from a receiver located within the validity area of each set of DGNSS corrections.

One possibility is to have a dedicated network of GNSS receivers. These receivers shall be capable of transmitting (via internet) the raw data collected to the Central Facility.

Another option is to get the GNSS raw data (used for the integrity monitoring) from an existing network of GNSS receivers, when available<sup>5</sup>. The main disadvantage of this solution is that the AtoN provider needs to rely on an external entity, so it could be necessary (service provider decision) to establish a Service Level Agreement (SLA) to guarantee the reception of the data with the quality and availability required.

- *AIS Network*

The RTCM corrections generated by the central facility are transmitted to the AIS Network which converts them in an *IEC 61162 VDM* sentence (discarding the preamble and parity fields) to be then distributed to the final users by the AIS base stations using the VDL channel.

Internally to the AIS network each corrections set will be routed to the target AIS Base Station (AIS-PCU).

<sup>5</sup> E.g., in europe [http://www.epncb.oma.be/\\_networkdata/stationmaps.php](http://www.epncb.oma.be/_networkdata/stationmaps.php)

It is important to remark that this component does not need to be modified with respect to a classical DGNSS solution. All the inputs/outputs are the same and in the same format, therefore, no change is required. This means that the fact that the RTCM corrections are generated based on the SBAS message or by a classical DGNSS reference station is completely transparent for the AIS network.

Regarding the trade-off assessment presented in Table 3, the analysis of the key features improved or degraded with respect to the baseline architecture is detailed hereafter

- **Infrastructure reduction.** As mentioned before, no RS neither IM is needed at each AIS Base Station for the AIS Message 17 generation. Being possible therefore to reduce the HW and SW components needed at each station, with the consequent benefits in terms of deployment cost, power consumption, maintenance cost or operational procedures
- **Local effects & Multipath.** Local effects such as multipath, receiver noise or masking effects would have no impact on the quality of the corrections provided through the AIS #17 message.
- **Communication lines.** -Given that the present solution does not consider any local backup, high availability communication lines are required to connect to each AIS Base Station.
- **Jamming and Spoofing Resilience.** Considering that the SBAS-based corrections are generated, and integrity checked in a central facility (not at each station), an eventual jamming or spoofing attack in the vicinity of the AIS Base Station would have no impact on the service.
- **Customized corrections for each AIS Base Station.** As detailed before, one of the advantages of the previous solution is that customized pseudorange corrections can be generated for each AIS Base Station, reducing the baseline distance between the rover position and the corrections reference.

#### 4.2.4. DECENTRALIZED SBAS BASED DGNSS SOLUTION OVER AIS SERVICE

The source for the generation of the DGNSS corrections to be broadcast by the AIS station is the SBAS message.

The DGNSS corrections are provided as input (via a dedicated port) to the AIS Base Station, therefore, whether these corrections are received from a classical DGNSS stations or generated based on SBAS, is completely transparent for the AIS Base Station. Taking this into account, it is not necessary to do any change on the AIS Base Station but only on the external reference station and Integrity Monitoring (RS & IM). The external RS shall be replaced by a RS software to produce the differential GNSS correction taking the SBAS messages as input. This component would basically consist of an RTCA to RTCM converter (See ANNEX E). A pre-broadcast integrity monitoring concept could be implemented to check the integrity of the differential corrections generated by the SBAS based RS.

A block diagram of the resulting RS & IM, including both HW and SW components is included hereafter in figure 10. It is to be noted that the SBAS message and the GNSS ephemeris can be obtained from an SBAS enabled receiver or from the Internet-based SBAS access point. Regarding the GNSS raw data needed to check integrity of the corrections, this data could be obtained from a dedicated GNSS receiver or from one of the different networks of receivers available (via internet/Ntrip).

In case of using, an SBAS enabled receiver to obtain the SBAS message (instead of the Internet-based SBAS access point), it could be considered using the GNSS observations collected by this receiver to check the integrity of the data (note that the observations are not used to generate the differential corrections).



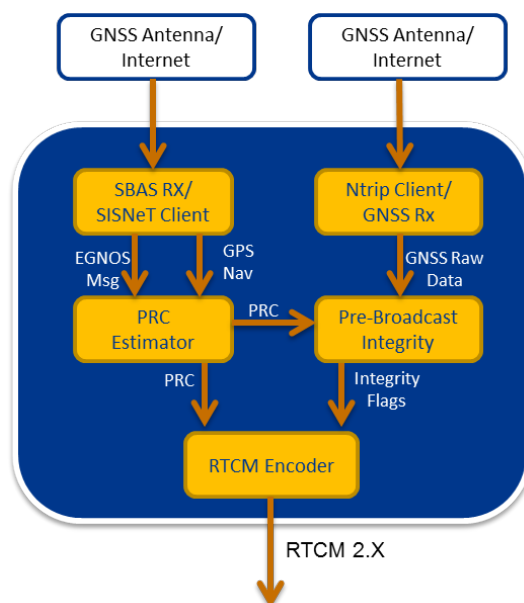

Figure 10 SBAS based AIS station: RS & IM block diagram

The corrections generated will be provided to the AIS Base Station in RTCM format via the dedicated input port and therefore, there will be no change with respect to the current interface. As detailed above, it is important to remark that this solution is completely transparent for the base station itself, since it receives the corrections in RTCM format regardless they are generated by a classical reference station or converted from the SBAS message to RTCM format.

Finally, the rationale for the assessment presented in Table 3 is detailed below:

- **Local effects & Multipath:** Refer to the previous section.
- **Communication line:** In case the SBAS data is obtained from the Internet-based SBAS access point, high requirements concerning the availability and quality of the communication links are needed since there is no other backup available.
- **Jamming and Spoofing Resilience:** An eventual jamming or spoofing attack in the vicinity of the AIS Base Station would have no impact on the service in case of using the Internet-based SBAS access point to obtain the SBAS data and the GNSS ephemerids.

#### 4.3. SBAS OVER OTHER DATA CHANNELS UNDER DEVELOPMENT SUCH AS VDES (VHF DATA EXCHANGE SYSTEM)

It has to be noted that most of the considerations set out for AIS into this document are also applicable to the future developments of VDES (VDES includes the combination of AIS, ASM and VDE channels).

The VDES Technical and Operational requirements are being defined under the framework of the IALA ENAV WG3 at the time this guideline is being written.

VDES additional channels will be available solving some of the current limitations of AIS (e.g., channel load) and besides on the on board side the appropriate interfaces will be defined.

The definition of the VDES communication channels considers the possibility to broadcast SBAS corrections in RTCA format.

## 5. SBAS BENEFITS AND LIMITATIONS FOR THE SBAS USE VIA ATON

---

The use of SBAS-based solutions within the AtoN architectures provides several benefits including the following ones (depending on the specific implementation, architecture, scenario, etc.):

- *Infrastructure reduction at site* with the corresponding benefits in terms of deployment cost, power consumption, maintenance cost and operational procedures. The rationalization of the infrastructure in a centralized solution permits to rely on a more agile and lighter architecture, consisting of a smaller number of devices and tools, also for maintenance purposes. In return, on some occasions this *may* derive on a reduced number of man-days effort required to perform the maintenance activities.

For example, in the case of the VRS centralized approach it is possible to optimize the on-site Reference Station and integrity monitoring HW (see section 4.1) with the associated cost savings.

- *Increased infrastructure robustness against Local effects, Multipath & Failures.* The only information needed for the generation of SBAS-based DGNSS streams is the SBAS message, time, and the GNSS ephemeris. The GNSS raw observations are not used and therefore, any local effects such as multipath or receiver clock jump/offset would not impact the quality of the corrections.

In addition, when SBAS is used in combination with traditional DGNSS (hybrid solution), it introduces redundancy on the source of the corrections. Furthermore, SBAS corrections can be obtained via a double source: SiS or Internet-based SBAS access point. This implies that, when a source of corrections fails, the system can automatically switch to a different source to avoid service interruption. Thus, the system is more robust to potential malfunctions coming either from HW failures or SW failures.

- *Jamming/spoofing resilience.* In line with the previous point, depending on the architecture design, an eventual jamming attack would have no impact on the SBAS-based solution. This could be achieved by obtaining the SBAS message and the GPS ephemeris from the Internet-based SBAS access point or by having two SBAS enabled receivers in two different locations. Thus, in an SBAS-based centralized architecture, Reference Stations (RS) are virtualized and therefore, cannot be jammed or spoofed. Only Integrity Monitoring Stations (IMS) can suffer this attack, which can be minimized by adding redundant IMS. In traditional DGNSS systems, however, since normally both RS and IMS are co-located, they can be equally jammed/spoofed.
- *Synergies between IALA Radio Beacons and AIS systems.* A centralized SBAS solution could increase synergies between IALA Radio Beacons and AIS systems, since the central server could generate corrections for both systems in an efficient way thanks to the VRS concept. These synergies could in return decrease the costs of generating corrections to be broadcasted by both systems.
- *Enhanced integrity at system level:* SBAS messages contain *integrity alerts* either in the Integrity Information Message (MT6), the Fast Corrections Messages (MT2 to MT5 and MT24) or iono correction messages (MT26). The application SW will map these integrity alerts into *DGNSS RTCM format* for transmission by either setting the DGNSS MT1/9 PRC field to binary 1000 0000 0000 0000 (which means this satellite cannot be used for the navigation solution) or even, when the alert condition affects all satellites, by setting the Station Health field to “not working”. On top of the SBAS integrity check, the DGNSS system will continue providing alerts also at system integrity monitoring level, as they currently do.

For the benefits previously pointed out (local effects and jamming/spoofing) it is noted that depending on the location of the GNSS receivers used for the integrity check, the IM module may be also affected and therefore the SBAS-based solution as well.

Conversely, there are several limitations including the following ones:

- *SBAS service areas are limited.* Currently SBAS services have regional coverage nevertheless the trend is SBAS services to expand their coverage areas in order to maximize the service coverage over the globe. See ANNEX D.

It is also important to note that currently not all SBAS providers have declared a specific service for maritime use.

- *Satellites shadowing limiting the SBAS SiS access.* It can be scenarios where the transmitting stations (DGNS, AIS, VDES) can be allocated in a place with limited access to the satellite SiS and therefore the SBAS use can be impacted.
- *Not direct control of the SBAS data by the AtoN provider.* SBAS services are not under the Maritime Authorities or Service providers direct control and therefore depending on the regulatory framework in some countries a working arrangement with the SBAS provider should be established to guarantee the appropriate service level. See operational aspects on section 6.
- *Potential hackability of centralized architectures.* Those architectures that rely on a centralized approach on which corrections are computed in a central facility and then transmitted through internet to the DGNS and AIS stations are susceptible to be hacked. This limitation is not a problem in architectures on which the corrections are generated on site. To mitigate this limitation a secured communication channel should be established (e.g., using NTRIP Transport Layer Security (TLS) option would be recommended).

On top of that, for the SBAS-based corrections over AIS, the following limitations are to be considered:

- The potential *VDL loading* caused by DGNS corrections transmission through AIS #17 message is to be considered by the AIS provider. It is noted that the estimated load for the transmission of SBAS corrections by one single AIS station is around 1% of VDL capacity [2] [32]. VDL load will increase in case of having several neighbouring AIS stations. This potential limitation is expected to be mitigated by the future VDE channels
- Corrections through AIS #17 message are not used by the main navigation receiver for SOLAS vessels. However, it is used in inland waterways vessels and by the VTS.

## 6. OPERATIONAL ASPECTS

It must be considered that even if the source of data is SBAS, the performances requirements included at IALA Recommendation *R0121* and Guideline *G1112* must be fulfilled.

The same recommendations related to operational aspects included at IALA Guideline *G1112* are to be considered in case of the SBAS use via AtoN, notably those addressing at least:

- Operation and maintenance
- Performance verification
- Publication of information

In order to ensure compliance with the Guideline *G1112*, AtoN providers considering utilization of SBAS are recommended to consult the SBAS service provider and establish appropriate working arrangements. These working arrangements should include at least:



- Provision of Information related to the SBAS service degradation and maintenance activities
- Provision of Information related to the Service characteristics (Performances, coverage area, etc.)
- Establishment of a Liability scheme
  - Provision of alarms/alerts procedure in relation with service degradations
  - Commitment about the long term operation of the service

## 7. ABBREVIATIONS

---

AIS	Automatic Identification System
ASM	Application Specific Messages
AtoN	Marine Aid(s) to Navigation
ATU	Antenna Training Unit
CF	Central facility
CS	Control Station
DGNSS	Differential Global Navigation Satellite System
DFMC	Dual Frequency Multiconstellation
DGPS	Differential Global Positioning System
EC	European Commission
EDAS	EGNOS Data Access Service
EGNOS	European Geostationary Navigation Overlay Service
EMRF	European Maritime Radionavigation Forum
ESA	European Space Agency
ESSP	European Satellite Services provider
GEO	Geostationary
GLONASS	Globalnaya Navigatsionnaya Sputnikovaya Sistema
GNSS	Global Navigation Satellite System
GPS	Global Positioning System
EUSPA	European Union for Space Programs Agency
HW	Hardware
IALA	International Association of Marine Aids to Navigation and Lighthouse Authorities
IEC	International Electro technical Commission
IWG	Interoperability Working Group
IM	Integrity monitoring
IMO	International Maritime Organization (UN)
kHz	kilohertz
LoS	Line of Sight
LSS	Logical Shore Station (AIS)
MF	Medium Frequency (300 kHz to 3 MHz)
MFMC	Multifrequency Multiconstellation
Msg	Message
MSK	Minimum Shift Keying



MT	Message type (AIS)
NM	Nautical mile
Ntrip	Networked Transport of RTCM via Internet Protocol
PCU	PSS Control Unit (AIS)
PNT	Position, Navigation and Timing
PR	Pseudorange
PRC	Pseudorange Correction(s)
RHCP	Right-Hand Circularly Polarized
RIMS	Ranging and Integrity Monitoring Stations (SBAS)
RS	Reference Station
RSIM	Reference Station - Integrity Monitor
RTCA	Radio Technical Commission for Aeronautics
RTCM	Radio Technical Commission for Maritime Services
Rx	Receiver / Reception
SBAS	Satellite-Based Augmentation System
SiS	Signal in Space
SLA	Service Level Agreement
SW	Software
Tx	Transmitter / Transmission
UDRE	User Differential Range Error (GPS)
VDES	Very High Frequency Data Exchange System
VDL	VHF Data Link
VRS	Virtual Reference Station
WAAS	Wide Area Augmentation System
WGS84	World Geodetic System 1984 (Reference coordinate system used by GPS)

## 8. REFERENCES

- [1] IALA Guideline G1029 On Ship-Borne Automatic Identification System (AIS) Volume I Part II: Technical Aspects of AIS, Edition 1.1, December 2002
- [2] IALA Recommendation A-124 Appendix 16 – DGNSS Broadcasts from an AIS Service
- [3] IALA Recommendation A-124 Appendix 4 –Interaction and Data Flow Model December 2011
- [4] IALA Guideline G1112, Performance and Monitoring of DGNSS Services in the Frequency Band 283.5 – 325 kHz, Edition 1, May 2015
- [5] RTCM Standard 10401.2 for Differential Navstar GPS Reference Stations and Integrity Monitors (RSIM), December 18, 2006
- [6] RTCM 10402.3 Recommended Standards for Differential GNSS services, August 20, 2001
- [7] SISNeT User Interface Document, E-RD-SYS-E31-010, Issue 3, Rev. 1.
- [8] EDAS Service Definition Document, Issue 2.1, December 19 2014 ([https://egnos-user-support.essp-sas.eu/new\\_egnos\\_ops/sites/default/files/library/official\\_docs/egnos\\_edas\\_sdd\\_in\\_force.pdf](https://egnos-user-support.essp-sas.eu/new_egnos_ops/sites/default/files/library/official_docs/egnos_edas_sdd_in_force.pdf)).
- [9] Global SBAS Status - Interoperability Working Group (IWG) - June 2016



- [10] European GNSS Agency: <https://www.EUSPA.europa.eu>
- [11] EUSPA EGNOS portal: [https://egnos-user-support.essp-sas.eu/new\\_egnos\\_ops/](https://egnos-user-support.essp-sas.eu/new_egnos_ops/)
- [12] IMO Resolution A.1046 (27) on the World Wide Radio Navigation System (WWRNS).
- [13] MOPS DO-229D Minimum Operational Performance Standards for Global Positioning System/Wide Area Augmentation System Airborne Equipment, 12/13/2006
- [14] ENAV18-13.20 Transmission of SBAS corrections over IALA beacons
- [15] ENAV19-13.13 Relevant architectures for the transmission of SBAS corrections over existing maritime AtoN - two cases studies: IALA beacon and AIS
- [16] ENAV18-13.16 Transmission of SBAS corrections over AIS
- [17] ENAV18-13.20 Transmission of SBAS corrections over IALA beacons
- [18] SISNeT User Interface Document, E-RD-SYS-E31-010, Issue 3, Rev. 1.
- [19] EDAS Service Definition Document, Issue 2.1, December 19 2014
- [20] IALA Guideline G1053. The Submission of a DGNSS Service for Recognition as a Component of the IMO WWRNS Edition 1, IALA, December 2006
- [21] World Wide Radio Navigation Plan Edition 2, IALA, December 2012
- [22] IALA NAV Guide 2018
- [23] Revised maritime policy and requirements for a future GNSS, IMO A.915(22), 29 November 2001
- [24] IMO MSC.401 (95) Performance standards for multi-system Receivers
- [25] IALA NAV Guide 2014
- [26] GNSS Market Report Issue 5, April 2017.  
[https://www.EUSPA.europa.eu/system/files/reports/gnss\\_mr\\_2017.pdf](https://www.EUSPA.europa.eu/system/files/reports/gnss_mr_2017.pdf)
- [27] GNSS Market Report Issue 4, March 2015. [https://www.EUSPA.europa.eu/system/files/reports/GNSS-Market-Report-2015-issue4\\_0.pdf](https://www.EUSPA.europa.eu/system/files/reports/GNSS-Market-Report-2015-issue4_0.pdf)
- [28] EUSPA/ESSP Market Status and Adoption Plan 2016- 2017
- [29] SISNeT User Interface Document, E-RD-SYS-31-010, Version 3, Revision 1, 15/05/2006.  
[http://www.egnos-pro.esa.int/Publications/SISNET/SISNET\\_UID\\_3\\_1.pdf](http://www.egnos-pro.esa.int/Publications/SISNET/SISNET_UID_3_1.pdf)
- [30] Networked Transport of RTCM via Internet Protocol (Ntrip), version 1.0, <http://www.rtcn.org/orderinfo.php>
- [31] IMO Guidelines for shipborne PNT (data processing). IMO MSC, 2017
- [32] IALA AIS Guideline G1029, Volume 1, Part 2
- [33] Technical characteristics for an automatic identification system using time-division multiple access in the VHF maritime mobile band, ITU-R M.1371-5
- [34] Generic Cost Analysis focus on relevant architectures for the transmissions of SBAS corrections over IALA beacon and AIS. ENAV-20.13.16

## ANNEX A SBAS BASIC ARCHITECTURES

The main elements of a basic SBAS architecture are:

### A. Space segment:

Includes the satellites with payloads aimed to transmit the corrections to the GNSS core constellations L1<sup>6</sup> and integrity information.

### B. Ground segment:

Includes all the ground elements in charge of the provision of the SBAS navigation message. The main elements are:

- Monitoring Station Network.
- Processing Facility Centre.
- Satellite Control Centre.
- Communication Layer.

### C. User segment:

Includes the user equipment needed to receive and use the SBAS information.

The schematic basic functional architecture of an SBAS system is shown below.

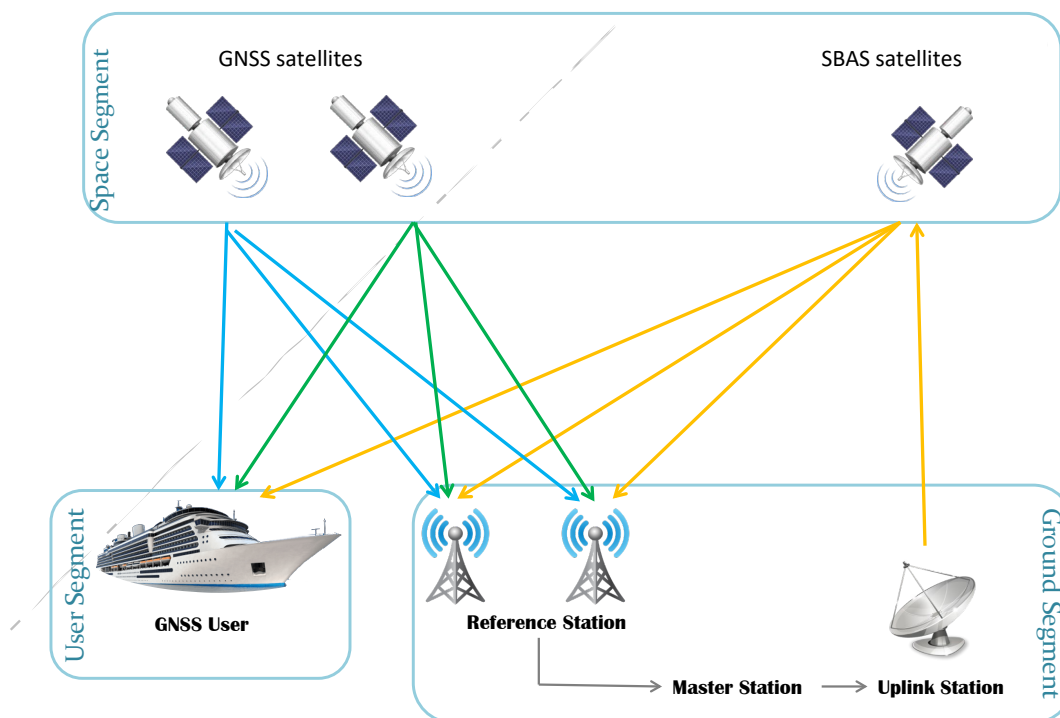

Figure 11 Basic SBAS Architecture

## ANNEX B SBAS SIS AND MESSAGES

The basic SBAS SiS characteristics are:

- Frequency: 1575.42 MHz (L1)
- Polarization: RHCP
- Data rate: 250 bit per second
- Format summary: All messages shall consist of
  - Message type identifier
  - Preamble
  - Data field
  - Cyclic redundancy check

The broadcast signal is a combination of a 1023-bit PRN navigation code of the GNSS and a 250 bits per second navigation data message carrying the corrections and integrity data elaborated by the SBAS ground segment. The SBAS messages structure is schematically shown in Figure 12.

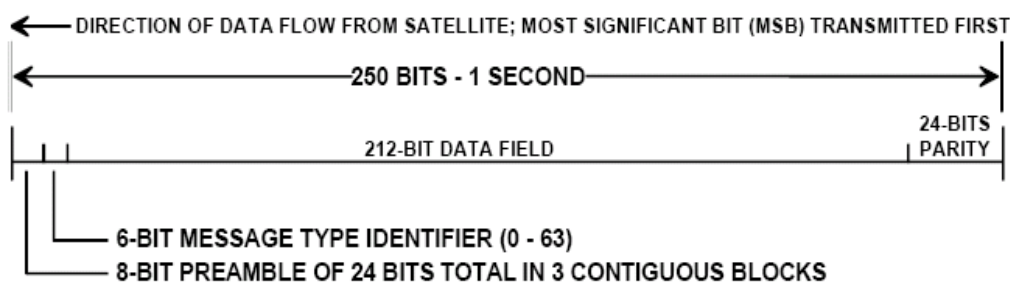

Figure 12 SBAS Messages. RTCA DO-229D

The content of each SBAS message type is summarized below:

Table 4 E.g., SBAS Messages RTCA DO-229D

0	Don't Use for Safety Applications	Discard any ranging, corrections and integrity data from that PRN signal for safety applications.
1	PRN Mask assignments	Indicates the slots for GPS and Augmentation satellites provided data
2-5	Fast corrections	Range corrections and accuracy
6	Integrity information	Accuracy-bounding information for all satellites in one message
7	Fast correction degradation factor	Information about the degradation of the fast term corrections



9 <sup>7</sup>	Augmentation Satellite ranging function parameters	<b>SBAS satellites orbit information (ephemeris)</b>
10	Degradation parameters	<b>Information about the correction degradation upon message loss</b>
11	N/A	<b>Reserved for future messages</b>
12	SBAS network Time/UTC offset parameters	<b>Parameters for synchronisation of SBAS Network time with UTC</b>
13-16	N/A	<b>Reserved for future messages</b>
17	Augmentation satellite almanacs	<b>Augmentation Satellite Almanacs</b>
18	Ionospheric grid point masks	<b>Indicates for which geographical point ionospheric correction data is provided</b>
19-23	N/A	<b>Reserved for future messages</b>
24	Mixed fast/long-term satellite error corrections	<b>Fast-term error corrections for up to six satellites and long-term satellite error correction for one satellite in one message.</b>
25	Long-term satellite error corrections	<b>Corrections for satellite ephemeris and clock errors for up to two satellites</b>
26	Ionospheric delay corrections	<b>Vertical delays/accuracy bounds at given geographical points</b>
27	SBAS Service Message	<b>Determines the <math>\delta</math>UDRE factor applicable in the Service Area.</b>
28	Clock-Ephemeris Error Covariance Matrix	<b>Relative covariance matrix for clock and ephemeris errors. Used to specify the correction confidence as a function of the user location.</b>
29-61	N/A	<b>Reserved for future messages</b>
62	N/A	<b>Reserved (Internal Test Message)</b>
63	Null message	<b>Filler message if no other message is available</b>

The performance of the SBAS services is defined in terms of accuracy, integrity, continuity and availability.

---

<sup>7</sup> MT 9 is broadcast with some information about the orbital position of the broadcasting Augmentation satellite..

## ANNEX C IDENTIFICATION OF THE DIFFERENT EXISTING SBAS SYSTEMS, COVERAGE AND PERFORMANCES

As depicted in the IALA NAVGuide 2014 section 4 [25] several countries and regions have implemented their own Satellite-based Augmentation Systems and related services.

- USA: Wide Area Augmentation System (WAAS)
  - [https://www.faa.gov/about/office\\_org/headquarters\\_offices/ato/service\\_units/techops/navservices/gnss/waas/](https://www.faa.gov/about/office_org/headquarters_offices/ato/service_units/techops/navservices/gnss/waas/)
  - <https://www.navcen.uscg.gov/>
- Europe: European Geostationary Navigation Overlay Service (EGNOS)
  - <https://egnos-portal.EUSPA.europa.eu/>
  - [https://egnos-user-support.essp-sas.eu/new\\_egnos\\_ops/index.php](https://egnos-user-support.essp-sas.eu/new_egnos_ops/index.php)
- Russia: System for Differential Corrections and Monitoring (SDCM)
  - [http://www.sdcm.ru/index\\_eng.html](http://www.sdcm.ru/index_eng.html)
- Japan: Multi-functional Satellite Augmentation System (MSAS)
  - [http://www.kasc.go.jp/\\_english/msas\\_01.htm](http://www.kasc.go.jp/_english/msas_01.htm)
- India: GPS and GEO Augmented Navigation (GAGAN)
  - <http://www.isro.gov.in/>
- China: BeiDou Satellite-based Augmentation System (BDSBAS).
- Republic of Korea: Korea Augmentation Satellite System (KASS). (in development)
  - [www.kass-eng.re.kr](http://www.kass-eng.re.kr)
- [10] Presents schematically the Service coverage of the world's SBAS systems.

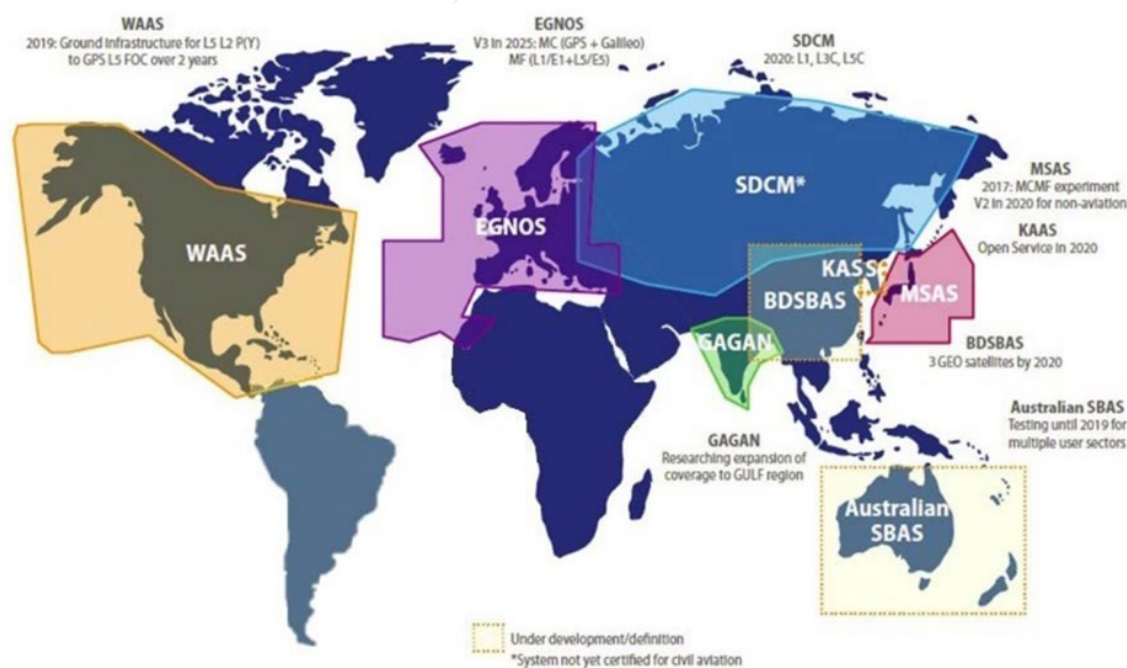

Figure 13 SBAS systems indicative coverage (source EUSPA[10])

## ANNEX D SBAS FUTURE DEVELOPMENTS AND TRENDS

The evolution of the SBAS services in the medium term will be mainly focused on the:

- a) Extension of Service coverage (e.g., EGNOS V3, WAAS Phase IV)

With the intention to indicate the availability coverage of the worldwide SBAS Single Frequency Single constellation the figure below shows the current coverage maps.<sup>8</sup>

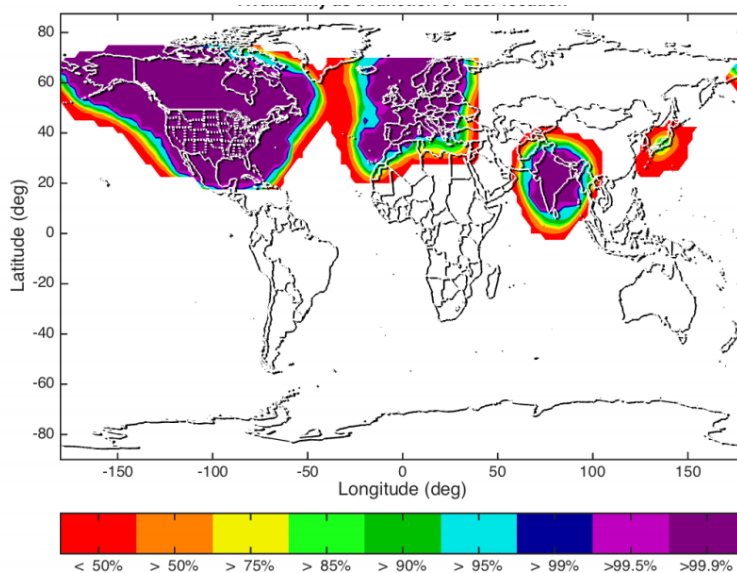

Figure 14 Availability map of Single Frequency, Single Constellation SBAS<sup>9</sup>

- b) Implementation of the Dual Frequency Multiconstellation (DFMC) concept

The implementation of dual frequency services (e.g., L1 and L5) will make SBAS SiS fully robust against ionospheric gradients<sup>10</sup>.

The following figure schematically shows the frequencies and bandwidths allocated to GPS, GLONASS, and Galileo.

<sup>8</sup> Note that the availability map is just indicative and it is not taking into account IMO resolution A.1046.

<sup>9</sup> Global SBAS status. IWG- June, 2016

<sup>10</sup> <https://pdfs.semanticscholar.org/2901/ed2fff1945a6236b4f440d95d639f6862496.pdf>

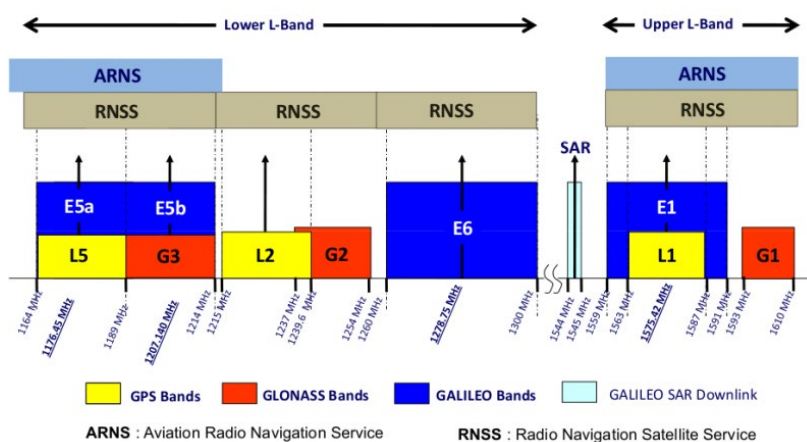

Figure 15 Frequencies and bandwidths allocated to GPS, GLONASS, and Galileo

As previously indicated the implementation of the SBAS DFMC concept will be deployed together with the Extension of the coverage areas as indicated in the following figure:

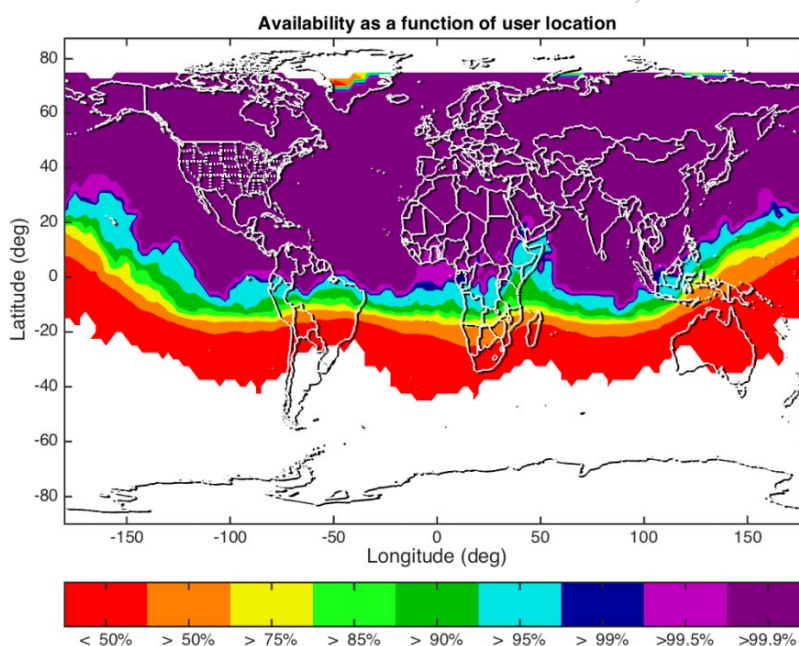

Figure 16 Generic view of 2025 Coverage of Dual Frequency, Multiple Constellation (DFMC) SBAS<sup>11</sup>

- c) Provision of improved SBAS availability and performance by direct mitigation of ionospheric signal delay
- d) Combination/augmentation of measurements from two or more core GNSS constellations out of four (GPS, GLONASS, Galileo, BeiDou)
- e) Improvement of robustness against unintentional interference

<sup>11</sup> SBAS integrity: Current Status & Future Perspectives, Per Enge, Stanford University- January 21,201

## ANNEX E MAPPING OF RTCA SBAS MESSAGES TO RTCM 2. X

This section provides a suggestion of how SBAS messages in RTCA format could be mapped into to RTCM 2.x format. It is not the intention to standardize the process but just to provide an illustrative example considering that different approaches could be implemented. Besides, the reader should note that this example is based on the RTCA MOPS [13] that currently only address GPS augmentation.

IALA DGNSS employs the principle that the main sources of error in satellite navigation (i.e., satellite clock errors, satellite ephemeris errors, tropospheric and ionospheric delay estimation errors) are highly correlated for two users located relatively close to each other. Differential GNSS corrections are computed by placing a reference station with a GNSS receiver at a known location, determining corrections to the satellite ranging signals, and broadcasting these corrections to users. This removes the bias errors common to the reference station and user receivers and improves the positional accuracy. User receiver noise, inter-channel biases, user local effects and differential station location uncertainty then limit the accuracy.

SBAS is also providing corrections to the same errors (i.e., satellite clock, ephemeris errors and ionospheric delay estimation errors), with one exception: the troposphere. For this error source, SBAS systems do not provide corrections; the conversion process will apply a model to reduce the error in the position due to this effect. Taking this into account, the SBAS messages can be used for the generation of Virtual Reference Stations (VRS). The principle behind this solution would be to convert the wide area SBAS corrections in RTCA format, into local area corrections in RTCM SC-104 format for the locations of interest (e.g., beacon locations).

For the sake of clarity, the Pseudorange corrections provided by SBAS will be called from now on SBAS PRC, the Pseudorange corrections calculated by DGNSS reference stations will be called DGNSS PRC and the Pseudorange corrections calculated which map SBAS differential corrections into RTCM format will be called S-DGNSS PRC.

### E.1. PSEUDORANGE RATE CORRECTIONS FOR RTCM 2.X MT1/MT9

RTCM corrections can be reconstructed from SBAS provided data using the following equations:

$$PRC(t_{z-count}) = PRC(t_{of}) + RRC(t_{of}) \times (t_{z-count} - t_{of}) + \delta\Delta t(t_{z-count}) \times c + \varepsilon(t_{z-count}) + IC_i(t_{z-count}) + TC_i(t_{z-count})$$

Where:

$PRC(t_{z-count})$	is the RTCM MT1 PRC broadcast to the user
$PRC(t_{of})$	Is the most recent SBAS fast corrections MT2-5 and 25
$RRC(t_{of})$	Is the range rate corrections calculated according to equation A-17 in MOPS [13] Appendix A using the most recent fast correction and a previous one.
$t_{of}$	Time of applicability of the most recent SBAS fast correction
$t_{z-count}$	Reference time for the RTCM MT1 parameters
$\delta\Delta t(t_{z-count})$	SBAS clock correction from MT25 calculated according to MOPS Appendix A.
$c$	Speed of light $2.99792458 \times 10^8$ m/s
$\varepsilon(t_{z-count})$	SBAS ephemeris correction from MT25 projected to the radial direction user-satellite (line of sight). This radial

ephemeris correction is inaccurate as it is kept the same value for the whole period of use of the S-DGNSS PRC. For a pure SBAS user applying MOPS, the radial ephemeris correction is embedded in the satellite coordinate vector and therefore in the pseudorange calculation.

$IC_i(t_{z-count})$

Is the ionospheric delay calculated according to equation A-41 in MOPS Appendix A. Note this is always a negative value.

$TC_i(t_{z-count})$

Is the tropospheric delay calculated according to section A.4.2.4 in MOPS Appendix A. Note this is always a negative value.

The  $\varepsilon(t_{z-count})$  maximum error induced should be estimated. Furthermore, this error contribution is present in the RRC computation below, so it will be somewhat compensated by the PRC estimation mechanism which uses this RRC. It is to be confirmed that the residual effect might then be dependent on radial acceleration only.

The provision of the  $\varepsilon(t_{z-count})$  implies the need of the reference station to have track to that specific satellite. However, according to [5], DGNSS must send corrections to all satellites in view of the reference station. The satellites monitored by SBAS might be a different set of satellites than those in view from the DGNSS reference station. The corrections then shall be sent to the subset of GPS satellites monitored by SBAS and also in view from the station. For the GPS satellites in view by the reference station and not monitored by SBAS, the S-DGNSS PRC shall be set to 1000 0000 0000 0000 and the S-DGNSS RRC be set to 1000 0000, preventing the rover to use these satellites.

Upon the transmission of a new clock and ephemeris data from GPS, SBAS continues to broadcast corrections to the old long-term clock and ephemeris data for a period of 2 to 4 minutes so all the users can acquire the new GPS data. The corrections processor should consider this SBAS characteristic.

## E.2. RANGE RATE CORRECTIONS FOR RTCM 2.X MT1/MT9

DGNSS Range Rate Correction (RRC) is an attempt to "extend the life" of the pseudorange correction as it "grows old" [5]. A possible S-DGNSS RRC could be calculated using the difference between the last calculation of SBAS PRC and a previous one available at the corrections processor.

$$RRC(t_{z-count}) = \frac{PRC(t_{current}) - PRC(t_{previous})}{\Delta t}$$

Where:

$RRC(t_{z-count})$

is the RTCM MT1 RRC broadcast to the user

$PRC(t_{current})$

Is the most recent S-DGNSS PRC calculated using the last set of SBAS fast corrections available and its correspondent SBAS slow corrections and, ionospheric corrections.

$PRC(t_{previous})$

Is a previous S-DGNSS PRC calculated using a previous set of SBAS fast corrections available and its correspondent SBAS slow corrections and ionospheric corrections.

$t_{z-count}$

Reference time for the RTCM MT1 parameters

$\Delta t$

$(t_{current} - t_{previous})$

The calculation proposed is in line with MOPS DO-229D. However, other approaches may yield better RRC performance. DGNSS receiver typically uses a proprietary RRC algorithms based on a second order filter.

As the update rate of SBAS fast corrections (typically six seconds) could be higher than the DGNSS MT1 update rate, note that the most recent S-DGNSS and a previous S-DGNSS PRC not necessarily are the last two S-DGNSS broadcast in MT1. The S-DGNSS PRC is a “snapshot” of the whole SBAS corrections in the reference station at a specific epoch (slow, fast, ionosphere and troposphere), therefore the update rate might be selected by the reference station and there is no constraint from SBAS messages update rate.

### E.3. S-DGNSS UDRE

According to [5], DGNSS UDRE is a one-sigma estimate of the uncertainty in the pseudorange correction as estimated by the reference station, and combines the estimated effects of multipath, signal-to-noise ratio, and other effects. The DGNSS UDRE is not used to provide integrity information just to weight the measurements and obtain a more accurate solution.

In the other hand, SBAS UDRE provides integrity information for the SBAS user and it only bounds the combined fast and long term corrections. The S-DGNSS UDRE concept should be in line with DGPS UDRE concept (and not the SBAS UDRE). The calculation can be done following MOPS Appendix J.

$$\sigma_i^2 = \sigma_{i,flt}^2 + \sigma_{i,UIRE}^2 + \sigma_{i,TROPO}^2$$

Where

$\sigma_i^2$	S-DGNSS UDRE (squared) for a specific satellite at $t_{z-count}$
$\sigma_{i,flt}^2$	Model variance for the long term, fast and range rate corrections as defined in MOPS Appendix A and J
$\sigma_{i,UIRE}^2$	Model variance for the slant range ionospheric error as defined in MOPS Appendix A and J.
$\sigma_{i,TROPO}^2$	Model variance for the tropospheric error as defined in MOPS section A.4.2.5.

Sigma value obtained will be coded according to Table 4-6 and scaled according to Table 4-2 in [5]. Sigma values could vary depending on the location and time but typical ranges could be around 1 m and 5m. DGNSS UDRE scale factors such as 0.3, 0.5 or 0.75 might be the most used.

### E.4. S-DGNSS INTEGRITY ALERTS

SBAS sends integrity flags for GPS satellites. SBAS effective time to alert is 6 seconds. S-DGNSS must take advantage of the alert information broadcast by SBAS. S-DGNSS might set a satellite as “Do not Use” (DU) immediately using RTCM MT1 or MT9, if SBAS sets that satellite DU through SBAS MT6. For the specific satellite, the DGNSS MT1/9 PRC field shall be set to binary 1000 0000 0000 0000 [5] and MT1/9 RRC shall be set to binary 1000 0000 which indicates a problem and the User Equipment should immediately stop using this satellite.

Other possible situations when S-DGNSS must send an alert for a satellite are:

- When either the S-DGNSS PRC or the RRC is higher than the maximum range for PRC ( $\pm 10485.44\text{m}$ ) or RRC ( $\pm 4.064\text{m/s}$ ) allowed by RTCM MT1.
- When SBAS ionosphere corrections are not available for a satellite monitored by SBAS.

### E.5. SUMMARY S-DGNSS PARAMETERS

The parameters that must be included for each satellite in RTCM MT1/MT9 for S-DGNSS are:



Table 5 Derivation of  $S_{DGNSS}$

S-DGNSS Parameter for DGNSS MT1	Derived in
UDRE	$\sigma_i^2$
PRC	$PRC(t_{z-count})$
RRC	$RRC(t_{z-count})$
ISSUE OF DATA	Issue of data of the GNSS navigation data being used. Also included in MT25 of MOPS Appendix A of MOPS Appendix A [13]



## ANNEX F GENERIC COST ANALYSIS FOCUSED ON RELEVANT ARCHITECTURES FOR THE TRANSMISSION OF SBAS CORRECTIONS OVER IALA BEACON AND AIS

Based on the architectures proposed in this guidance material (see section 4), this annex highlights the main relevant outcomes of a generic Cost- Analysis focused on the most relevant potential architectures that could be used to broadcast DGNS corrections generated from the SBAS message (obtained from SIS and/or Internet-based service) over IALA beacons or AIS.

The assessment provides a costs' comparison between reference scenarios and SBAS-based alternate scenarios.

Throughout the annex the typical IALA DGNS and AIS architectures, based on current deployments and recommendations, are referred to as "Reference scenario". The SBAS-based architectures are referred to as "Alternate scenarios".

It is important to note that:

- The costs of the different infrastructures, used to obtain the results shown in this generic analysis, are based on the EGNOS Service Provider (ESSP) research information and assumptions; they have to be considered as an example to get the costs differences between different alternatives.
- The procurement and running costs vary from one country to another and even from one network to another. Therefore, it is essential not to take this information as "absolute" estimations since specific situations require a customized costs analysis.

There are several possibilities and configurations, which could bring cost savings in the short term, mainly due to the rationalization of part of the current infrastructure and the subsequent reduction in the operational expenditures. At the same time, these alternatives could respond to potential shore infrastructure obsolescence issues, being transparent to the final users (as the signal transmitted by those new proposed architectures is compatible with the user equipment already installed on-board the vessels). Obviously, it is recommended to assess which specific parts of the infrastructure could be reused, potential benefits of each proposal and other issues related with the architecture, prior to choose an alternative based only on potential savings.

### F.1. EXECUTIVE SUMMARY

There are some cases where SBAS-based alternatives could be introduced in IALA DGNS and AIS systems in a cost-effective way and transparent to the final users (as the signal transmitted by those new proposed architectures are absolutely compatible with the user equipment already installed on-board the vessels).

The assessment depicted in this annex has taken into account the modifications to be made in the reference scenario in order to implement different alternatives based on SBAS, as described in section 4.

#### SBAS over IALA beacons

In terms of CAPEX, the "Redundant Fully SBAS Based Solution" is the alternative requiring the highest upgrade investments. In addition, the "Hybrid Decentralized Architecture: Classical DGNS + SBAS (Internet-based SBAS access point) Based" requires lower investment than the "Hybrid Centralized Architecture: Classical DGNS + SBAS (Internet-based SBAS access point) Based VRS" when the number of stations to be upgraded is less than 15.

#### Infrastructure upgrade (10 stations):

- In case that an infrastructure's upgrade is possible, by reusing some parts of the current architecture, this analysis concludes that the most promising architecture in terms of costs is the "Hybrid Centralized". The payback would happen after three years of operation and the cumulative savings after 5 years of operation are higher than in the other alternatives.

### New infrastructure (10 stations):

- Taking as example the deployment based on 10 stations, this analysis concludes that the “Redundant fully SBAS” alternative is the most cost-effective if compared with the deployment of the reference scenario, both of them built from scratch.

### **SBAS over AIS**

### Infrastructure upgrade (20 stations):

- Analysing the evolution of cumulative costs (CAPEX and OPEX) along a timeframe period of 5 years in a network with 20 AIS Base Stations and 4 DGNSS beacons, it can be observed that when an infrastructure upgrade is done to build the decentralized alternate scenarios, a return of the investment is not possible. On the contrary, when an infrastructure upgrade is done to build the centralized alternate scenarios, in both of them a return of the investment will happen. The earliest return of the investment happens in the “Centralized - Internet-based SBAS access point” alternative. Hence, this would be the most promising alternative in terms of costs, in this situation.

### New infrastructure (20 stations):

- A completely new centralized option deployed for 20 AIS Base Stations is cheaper than the deployment of the reference scenario. Besides, the decrease in OPEX leads to a growing profit result along the years. Both centralized alternatives yield similar savings, being the “Centralized Internet-based SBAS access point” slightly better in terms of costs.

## **F.2. METHODOLOGY DESCRIPTION**

The methodology to implement this generic costs assessment for an AtoN provider consists of the following steps:

1. Identify the “reference” (current) and “alternate” (SBAS-based proposal) scenarios.
2. Set the hypotheses for the assessment.
3. Identify the costs applicable in both reference and alternate scenarios, focussing on the difference.
4. Make an economic analysis of the different proposals.
5. Draft conclusions.

### **F.2.1. COMMON ASSUMPTIONS AND DEFINITIONS**

Reference scenario:

- Both, centralized elements and the ones located at the station sites are considered. The number of units of each of them is based on a full-redundant architecture.
- **CAPEX-C:** Capital Expenditures which represent the value of the assets of the Complete infrastructure. It is calculated for five different placements, according to the number of stations (1, 5, 10, 15 and 20). CAPEX of the overall architecture is useful to have an estimation of the cost of installing a new infrastructure according to the classical concept, but also to calculate part of the yearly operating expenditures (OPEX).
- **OPEX-C:** Considered as yearly Operating Expenditures associated to the complete infrastructure, which include maintenance and communication lines. OPEX is highly dependable on specific contracts and difficult to estimate on a generic basis. The approach for estimating annual operating expenditures has been the sum of two addends:
  - A fixed percentage of the capital expenditure. In the analysis, this addend has been estimated in a 12% of the CAPEX.
  - Communications’ costs, according to the rationale explained in section F.2.2.

### Alternate scenarios:

- **CAPEX-C:** This is calculated in the same way as the reference scenario. CAPEX of the Complete architecture from scratch is useful to have an estimation of the cost of installing a new infrastructure according to the SBAS-based concept, but also to calculate part of the yearly operating expenditures.
- **CAPEX-U:** CAPEX related to an infrastructure Upgrade. This cost accounts for the investment in new components required in the SBAS-based architectures.
- **OPEX-C:** It is calculated in the same way as the reference scenario. The approach for estimating annual operating expenditures of the Complete architecture has been the sum of two addends:
  - A fixed percentage of the capital expenditure. In the analysis, this addend has been estimated in a 12% of the CAPEX.
  - Communications' costs, taking into account the necessary upgrades in centralized and/or internet-based SBAS access point based architectures, according to the rationale explained in section F.2.2.

### Costs comparison:

- **CAPEX-D:** This is the Difference between the CAPEX-C in an alternative scenario and the CAPEX-C in the reference scenario.
- **OPEX-D:** This is the Difference between the OPEX-C in an alternative scenario and the OPEX-C in the reference scenario.
- **Delta-C:** This cost represents the cumulative difference in costs along the years for Completely new infrastructures, comparing the deployment of a classical architecture (reference scenario) with the deployment of an SBAS-based architecture (alternate scenario) from scratch. The same calculus is made for different years (1, 2, 3, 4, 5 and 20) to have an overview of savings or increases in costs.

It has been calculated the difference in CAPEX plus OPEX between the deployment of a reference scenario and the deployment of an alternate scenario with the same number of broadcasting stations.

Green figures represent a cost reduction, while red figures mean a cost increase.

- **Delta-U:** This cost represents the cumulative difference in costs along the years for infrastructure Upgrades, comparing the operational costs in a classical architecture (reference scenario) with the investment in upgrading an existing infrastructure to become an SBAS-based architecture (alternate scenario), including also the operational costs. The same calculus is made for different years (1, 2, 3, 4, 5 and 20) to have an overview of savings or increases in costs.

The first year includes the investment in CAPEX due to the provision of new components and the OPEX associated to the first year of operation. The second year accumulates the expenditures in the first year plus the OPEX associated to the second year of operation (investment in new elements is only considered in the first year). The same rationale is followed for the rest of the years.

Green figures represent a cost reduction, while red figures mean a cost increase.

- **Payback:** As the first year after an infrastructure upgrade when the investment is recovered and a positive return occurs.

## **F.2.2. COMMUNICATIONS COSTS ASSUMPTIONS**

**Communications' costs** are considered as part of the OPEX and the following assumptions have been taken in this analysis:

- In the IALA DGNS case, an Internet connection is assumed available at the radio beacon sites and at the Central Monitoring Centre based on access to public networks. Since dedicated lines are not deployed, there are not a CAPEX associated to communications but an OPEX to account for the Internet access. In the

AIS architecture, the AIS Base Stations are connected through an IP based communication network with the Central Segment.

- Availability of communications is essential in case of internet-based SBAS access point based architectures and/or centralized proposals. In such cases, it has been assumed a cost increment in the OPEX, due to the upgrade of the contract with the ISP (Internet Service Provider), to reinforce reliability of the connection and increased data volume.
- To be noted that prices can differ depending on the region. For example, in case of European countries these prices can vary up to 400%, according to EC studies. These differences make it difficult to establish a common price for a generic costs analysis.
- Current estimated prices (OPEX):
  - At each radio beacon: “Basic Internet connection<sup>12</sup>”.
  - At Central Monitoring Centre: “Broadband Internet connection<sup>13</sup>”.
- Estimated prices for the upgrade in case of full-internet-based SBAS access point based architectures and/or full-centralized proposals (OPEX):
  - At each beacon: High availability Internet connection, with a cost 5 times higher than “Basic Internet connection”.
  - At Central Monitoring Centre: Broadband Internet connection with improved availability and bandwidth, with a cost 2 times higher than just “Broadband Internet connection”.

### **F.3. SBAS OVER IALA BEACONS: GENERIC COST ASSESSMENT**

#### **I. Reference scenario: baseline IALA DGNSS infrastructure**

The reference scenario is the one included in Figure 3.

#### **II. Alternate scenarios: Cost analysis of the SBAS over IALA DGNSS options**

The alternate scenarios are the ones proposed in section 4.1.

##### **A. Hybrid Decentralized Architecture: Classical DGNSS + SBAS (SiS or Internet-based SBAS access point) Based**

This architecture is the one described in section 4.1.3 and depicted in Figure 4. To be noted that in this cost assessment the use of an Internet-based SBAS access point to access the SBAS augmentation message has been considered.

The main qualitative cost analysis results are:

- CAPEX in a completely new infrastructure based on SBAS is slightly lower compared to CAPEX in the reference scenario.
- The removal of components on site entails a reduction in the maintenance costs. Standard communication lines remains unchanged at each radio beacon. Therefore, OPEX decreases in the SBAS-based option.
- The payback due to the savings in OPEX happens as of the 5<sup>th</sup> year since the infrastructure upgrade in all the study cases (1, 5, 10, 15 and 20 stations).

---

<sup>12</sup> A “basic internet connection” can be defined as an ADSL2 (ITU G992.3) connection, with an asymmetric 12Mbps downstream and 1 Mbps upstream.

<sup>13</sup> A “broadband internet connection” can be defined as a Fibre internet connection with a minimum symmetric 100 Mbps downstream/upstream.

## **B. Hybrid Centralized Architecture: Classical DGNSS + SBAS (SiS or Internet-based SBAS access point) Based VRS**

This architecture is the one described in section 4.1.4 and depicted in **Error! Reference source not found.**. To be noted that in this cost assessment the use of an Internet-based SBAS access point to access the SBAS augmentation message has been considered.

The main qualitative cost analysis results are:

- CAPEX in a completely new infrastructure based on SBAS is lower compared to CAPEX in the reference scenario, except in the case that there is only one station (a centralized architecture does not make sense in this situation).
- The removal of components on site entails a reduction in the maintenance costs, which balances out the OPEX increase due to the upgrade of the contract with the communications provider. This upgrade is needed since this is a centralized architecture.
- In an infrastructure with 5 broadcast sites, the payback due to the savings in OPEX happens as of the 7<sup>th</sup> year since the infrastructure upgrade. The same happens as of the 3<sup>rd</sup> year if there are 10 broadcast sites; or as of the 2<sup>nd</sup> year if there are 15 or 20 broadcast sites.

## **C. Redundant Fully SBAS Based Solution**

This architecture is the one described in section 4.1.5 and depicted in Figure 6. To be noted that in this cost assessment the use of an Internet-based SBAS access point to access the SBAS augmentation message in the centralized part of the architecture has been considered. At each radio beacon site, an SBAS receiver and also an Internet-based SBAS access point client have been included.

The main qualitative cost analysis results are:

- CAPEX in a completely new infrastructure based on SBAS is lower compared to CAPEX in the reference scenario, except in the case that there is only one station (a centralized architecture does not make sense in this situation).
- The removal of components on site entails a reduction in the maintenance costs, which balances out the OPEX increase due to the upgrade of the contract with the communications provider. This upgrade is needed since this is a centralized architecture.
- In an infrastructure with 10 broadcast sites, the payback due to the savings in OPEX happens as of the 6<sup>th</sup> year since the infrastructure upgrade. The same happens as of the 5<sup>th</sup> year if there are 15 or 20 broadcast sites.

## **III. Costs comparison**

The performed analysis has taken into account the modifications to be made in the reference scenario in order to implement 3 different alternatives, according to the trade-off analysis in section 4.1.2.

CAPEX is directly related with the number of IALA beacons, either in the reference scenario or in the proposed alternatives, being worth implementing a centralized architecture only when there are more than one broadcast stations.

In terms of CAPEX, the “Redundant Fully SBAS Based Solution” is the alternative requiring the highest upgrade investments. In addition, the “Hybrid Decentralized Architecture: Classical DGNSS + SBAS (Internet-based SBAS access point) Based” requires lower investment than the “Hybrid Centralized Architecture: Classical DGNSS + SBAS (Internet-based SBAS access point) Based VRS” when the number of stations to be upgraded is less than 15.

In regards to the evolution of the operational expenditures in the alternate scenarios compared with the reference scenario, they are clearly reduced as the number of onsite equipment decreases; even taking into account the upgrades of the contract with the internet service provider in the Central Facility.

## A. Infrastructure upgrade

Table 6 shows the relative investment in terms of CAPEX of each SBAS-based alternative, the variation in percentage of OPEX with regard to the reference scenario and the payback period. All these values apply to the 10 stations case when an infrastructure upgrade is done:

Table 6 Costs variation – 10 stations – infrastructure upgrade

10 stations Infrastructure upgrade	Hybrid Decentralized	Hybrid Centralized	Redundant fully SBAS
CAPEX-U	3%	4%	11%
OPEX-D	▼5,3%	▼13,7%	▼15,8%
Payback	5 <sup>th</sup> year	3 <sup>rd</sup> year	6 <sup>th</sup> year

In summary:

- CAPEX-U: CAPEX investment is shown as a percentage of the CAPEX for the reference scenario. The lowest investment is required by the “Hybrid Decentralized” architecture, while the highest corresponds to the “Redundant fully SBAS”.
- The three SBAS-based alternatives entail a yearly reduction in OPEX from 5% to almost 16% with regard to the OPEX of the reference scenario.
- Accrued savings after 5 years of operation are positive in the “Hybrid Decentralized” and “Hybrid Centralized” alternatives. Due to the higher yearly decrease in OPEX and the similar CAPEX investment, the accrued savings after 5 years in the “Hybrid Centralized” alternative are 32 times higher than in the “Hybrid Decentralized”.
- It is not possible to obtain any accrued saving after 5 years of operation in the “Redundant fully SBAS” since the payback period is 6 years.

In case that an infrastructure’s upgrade is possible, by reusing some parts of the current architecture, this analysis concludes that the most promising architecture in terms of costs is the “Hybrid Centralized”. The payback would happen after three years of operation and the cumulative savings after 5 years of operation are higher than in the other alternatives.

## B. New infrastructure

The following table summarizes the variation in percentage with regard to the CAPEX and OPEX of the reference scenario in the 10 stations case, assuming that the reference and the alternate scenarios are built from scratch:

Table 7 Costs variation – 10 stations – new infrastructure

10 stations New infrastructure	Hybrid Decentralized	Hybrid Centralized	Redundant fully SBAS
CAPEX-D	▼5,3%	▼14,8%	▼16,9%
OPEX-D	▼5,3%	▼13,7%	▼15,8%

In summary:

- The three SBAS-based alternatives entail a reduction in CAPEX from 5% to almost 17% with regard to the CAPEX of the reference scenario.
- The three SBAS-based alternatives entail a yearly reduction in OPEX from 5% to almost 16% with regard to the OPEX of the reference scenario (there is no difference with regard to the “infrastructure upgrade” case).

- Accrued savings after 5 years of operation are 2,75 times higher in the “Hybrid Centralized” than in the “Hybrid Decentralized”.
- Accrued savings after 5 years of operation are 3,14 times higher in the “Redundant fully SBAS” than in the “Hybrid Decentralized”.

Taking as example the deployment based on 10 stations, this analysis concludes that the “Redundant fully SBAS” alternative is the most cost-effective if compared with the deployment of the reference scenario, both of them built from scratch.

#### **F.4. SBAS OVER AIS: GENERIC COST ASSESSMENT**

The SBAS-based alternatives follow the high level architectures described in section 4.1.5 and 4.2 considering two different situations:

- AIS #1 – Infrastructure upgrade:
  - The reference scenario is an AIS network (implementing AIS #17 message) associated to an existing IALA DGNSS deployment. Corrections from the IALA DGNSS stations are used to feed the AIS Base Stations. As an assumption, one IALA beacon feeds five AIS Base Stations. Costs of the reference scenario include the AIS network and also the IALA DGNSS infrastructure.
  - The alternate scenarios analysed are decentralized (SBAS SIS and Internet-based SBAS access point) and centralized (SBAS SIS and Internet-based SBAS access point) assuming that the modifications are implemented in the IALA beacons.
- AIS #2 – New infrastructure:
  - The reference scenario is an AIS network (implementing AIS #17 message) associated to an IALA DGNSS infrastructure (to be deployed). Corrections from the IALA DGNSS stations are used to feed the AIS Base Stations. One IALA beacon feeds five AIS Base Stations.
  - The alternate scenario analysed is centralized (SBAS SIS and Internet-based SBAS access point) assuming that there is no IALA DGNSS infrastructure, hence a centralized computation of corrections is performed in the Central Segment.

##### **I. Reference scenario: baseline AIS infrastructure**

For the reference scenario, the following assumptions have been considered:

- The reference scenario is an AIS network (maritime or inland) with computation of DGNSS corrections; hence AIS # 17 message is implemented.
- It is assumed that the AIS Base Stations are ready to receive RTCM DGNSS corrections provided as input via a dedicated port.
- An external RS (with its corresponding IM) is in place and could be used to provide RTCM DGNSS corrections to the AIS Base Stations. It is not necessary to do any change on the AIS Base Station to obtain an SBAS-based alternative but only on the external reference station (RS).

##### **II. Alternate scenarios: Cost analysis of the SBAS over AIS options**

For the reference scenario, the following assumptions have been considered:

- In the decentralized options, the SBAS-based alternatives imply the modification of the DGNSS station, which feeds the AIS base station, and this AIS base station remains unchanged.
- In the centralized options, the SBAS-based alternatives imply the modification of the Central Segment in order to include the Processing Facility to generate the DGNSS corrections. AIS base stations remain unchanged.

## A. Decentralized – SBAS SIS

The main derived qualitative costs analysis results are:

- CAPEX and OPEX in the reference scenario include not only the AIS network related costs but also the DGNSS reference stations costs which are needed to provide the corrections.
- CAPEX in an infrastructure based on SBAS is lower than CAPEX in the reference scenario.
- OPEX decreases in the SBAS-based option, however this decrease does not allow to recover the required investment.

## B. Decentralized – Internet-based SBAS access point

The main derived qualitative costs analysis results are:

- CAPEX and OPEX in the reference scenario include not only the AIS network related costs but also the DGNSS reference stations costs which are needed to provide the corrections.
- CAPEX in an infrastructure based on SBAS is lower than CAPEX in the reference scenario.
- Despite of removing some elements on site, which entails a reduction in the maintenance costs, OPEX increases in the SBAS-based option due to the upgrade of the contract with the communications provider, since this is an architecture based on an Internet-based SBAS access point.

## C. Centralized – SBAS SIS

The main derived qualitative costs analysis results are:

### 1. Situation AIS #1 (Infrastructure upgrade):

- CAPEX in an infrastructure based on SBAS is lower than CAPEX in the reference scenario, except in the case that there are only one or two IALA DGNSS stations (a centralized architecture does not make sense in this situation).
- The removal of components in the IALA beacons entails a reduction in the maintenance costs, which balances out the OPEX increase due to the upgrade of the contract with the communications provider. This upgrade is needed since this is a centralized architecture.
- In an infrastructure with 20 AIS Base Stations attached to 4 IALA beacons, the payback due to the savings in OPEX happens as of the 13<sup>th</sup> year since the infrastructure upgrade.

### 2. Situation AIS #2 (New infrastructure):

- CAPEX and OPEX in the reference scenario include not only the AIS related costs but also the DGNSS reference stations costs, which are needed to provide the corrections.
- This analysis is focused in the cost comparison between the deployment of a decentralized infrastructure of IALA DGNSS stations to feed the AIS Base Stations (1 IALA beacon feeds 5 AIS base stations) and the deployment of a centralized alternative based on SBAS, without IALA DGNSS stations.
- CAPEX in a completely new infrastructure based on SBAS is lower compared to CAPEX in the reference scenario.
- The decrease of components on site entails a reduction in the maintenance costs, however OPEX increases due to the upgrade of the contract with the communications provider. This upgrade is needed since this is a centralized architecture. As of 15 AIS Base Stations OPEX decreases in the alternative scenario with regards to the reference one.



- According to the “Deltas for completely new infrastructure (cumulative)” a centralized option deployed for 5 AIS Base Stations is cheaper than the deployment of the reference scenario; however the increase in OPEX leads to a non-profitable result as of the 5<sup>th</sup> year of operation.
- According to the “Deltas for completely new infrastructure (cumulative), a centralized option deployed for 15 (or more) AIS Base Stations is cheaper than the deployment of the reference scenario; besides the decrease in OPEX leads to a growing profit result along the years.

#### **D. Centralized – Internet-based SBAS access point**

The main derived qualitative costs analysis results are:

##### **1. Situation AIS #1 (Infrastructure upgrade):**

- CAPEX and OPEX in the reference scenario include not only the AIS related costs but also the DGNS reference stations costs, which are needed to provide the corrections.
- CAPEX in an infrastructure based on an Internet-based SBAS access point is lower than CAPEX in the reference scenario, except in the case that there are only one or two IALA DGNS stations, (a centralized architecture does not make sense in this situation).
- The removal of components in the IALA beacons entails a reduction in the maintenance costs, which balances out the OPEX increase due to the upgrade of the contract with the communications provider.
- In an infrastructure with 20 AIS Base Stations attached to 4 IALA beacons, the payback due to the savings in OPEX happens as of the 11<sup>th</sup> year since the infrastructure upgrade.

##### **2. Situation AIS #2 (New infrastructure):**

- CAPEX and OPEX in the reference scenario include not only the AIS related costs but also the DGNS reference stations costs, which are needed to provide the corrections.
- This analysis is focused in the cost comparison between the deployment of a decentralized infrastructure of IALA DGNS stations to feed the AIS Base Stations (1 IALA beacon feeds 5 AIS base stations) and the deployment of a centralized alternative based on Internet-based SBAS access point, without IALA DGNS stations.
- CAPEX in a completely new infrastructure based on an Internet-based SBAS access point is lower compared to CAPEX in the reference scenario.
- The decrease of components on site entails a reduction in the maintenance costs, however OPEX increases due to the upgrade of the contract with the communications provider. This upgrade is needed since this is a centralized architecture based on an Internet-based SBAS access point. As of 15 AIS Base Stations OPEX decreases in the alternative scenario with regards to the reference one.
- According to the “Deltas for completely new infrastructure (cumulative), a centralized option deployed for 5 AIS Base Stations is cheaper than the deployment of the reference scenario; however the increase in OPEX leads to a non-profitable result as of the 7<sup>th</sup> year of operation.
- According to the “Deltas for completely new infrastructure (cumulative), a centralized option deployed for 15 (or more) AIS Base Stations is cheaper than the deployment of the reference scenario; besides the decrease in OPEX leads to a growing profit result along the years.

### **III. Costs comparison**

#### **1. Infrastructure upgrade – AIS #1**

The reference scenario is already deployed and the connected DGNS beacons are upgraded following a decentralized or centralized SBAS-based alternative.

In the decentralized options, CAPEX investment is directly related to the number of IALA beacons feeding the AIS network. Besides, the centralized alternatives are the ones requiring the highest upgrade investments in terms of CAPEX.

Regarding the evolution of the operational expenditures in the alternate scenarios compared with the reference scenario, they are clearly reduced as the number of onsite equipment decreases; that is in the centralized architectures, even taking into account the upgrades of the contract with the internet service provider.

The following table summarizes the costs results in a large size deployment, if referred to inland waters, or a medium-small size deployment, if referred to coastal AIS. This case analyses an infrastructure upgrade in a network with 20 AIS base stations.

Table 8 Costs variation – 20 stations – infrastructure upgrade

20 stations Infrastructure upgrade	Decentralized SBAS-SIS	Decentralized Internet-based SBAS access point	Centralized SBAS-SIS	Centralized Internet- based SBAS access point
CAPEX-U	5,2%	2,5%	9,6%	8,9%
OPEX-D	=	▲0,8%	▼5,9%	▼6,8%
Payback	NA	NA	13 <sup>th</sup> year	11 <sup>th</sup> year

In summary:

- CAPEX-U: CAPEX investment is shown as a percentage of the CAPEX for the reference scenario. The lowest investment is required by the “Decentralized Internet-based SBAS access point” architecture, while the highest corresponds to the “Centralized SBAS-SIS”.
- OPEX-D: OPEX remains almost unchanged in the decentralized options. As a consequence, the decentralized alternate scenarios entail an increase in the cumulative costs or a very slight decrease and a return of the investment is not possible in these alternatives (payback period Not Applicable).
- The centralized alternatives entail a yearly reduction in OPEX from 6% to almost 7% with regard to the OPEX of the reference scenario. As a consequence, the centralized alternate scenarios entail a decrease in the cumulative costs and in both of them a return of the investment will happen. The lowest payback period happens in the “Centralized - Internet-based SBAS access point” alternative, after 11 years of operation.

Analysing the evolution of cumulative costs (CAPEX and OPEX) along a timeframe period of 5 years in a network with 20 AIS Base Stations and 4 DGNSS beacons, it can be observed that when an infrastructure upgrade is done to build the decentralized alternate scenarios, a return of the investment is not possible. On the contrary, when an infrastructure upgrade is done to build the centralized alternate scenarios, in both of them a return of the investment will happen. The earliest return of the investment happens in the “Centralized - Internet-based SBAS access point” alternative. Hence, this would be the most promising alternative in terms of costs, in this situation (AIS #1).

## 2. New infrastructure – AIS #2

This analysis is focused in the cost comparison between the deployment of a decentralized infrastructure of IALA DGNSS stations to feed the AIS Base Stations (1 IALA beacon feeds 5 AIS base stations) and the deployment of a centralized alternative based on SBAS, without IALA DGNSS stations. In this situation a CAPEX investment is needed to implement AIS #17 message in both, the reference scenario and the SBAS-based alternatives. The required CAPEX investment is directly related with the number of AIS stations and higher in the reference scenario than in the centralized options.

In regards to the evolution of the operational expenditures in the alternate scenarios compared with the reference scenario, they decrease as the number of onsite equipment is reduced; that is in the centralized architectures, even taking into account the upgrades of the contract with the internet service provider.

The following table summarizes the costs results in a large size deployment, if referred to inland waters, or a medium-small size deployment, if referred to coastal AIS. This case analyses the deployment of a new infrastructure with 20 AIS base stations.

*Table 9 Costs variation – 20 stations – New infrastructure*

<b>20 stations New infrastructure</b>	<b>Centralized SBAS-SIS</b>	<b>Centralized Internet-based SBAS access point</b>
<b>CAPEX-D</b>	▼36,9%	▼37,6%
<b>OPEX-D</b>	▼8,9%	▼9,7%

In summary:

- The SBAS-based alternatives entail a reduction in CAPEX from 36,9% to 37,6% with regard to the CAPEX of the reference scenario.
- The SBAS-based alternatives entail a yearly reduction in OPEX from 9% to almost 10% with regard to the OPEX of the reference scenario.

A completely new centralized option deployed for 20 AIS Base Stations is cheaper than the deployment of the reference scenario. Besides, the decrease in OPEX leads to a growing profit result along the years. Both centralized alternatives yield similar savings, being the “Centralized Internet-based SBAS access point” slightly better in terms of costs.

## ANNEX G RECOMMENDATIONS

This annex states a set of general recommendations that authorities should consider when implementing an Aid to Navigation service based on SBAS (centralized or hybrid architectures):

- Ensure good **communications** lines both to transmit the corrections generated at the server as to get **raw data from the monitoring stations for pre-broadcast integrity monitoring (PBM)**
- Equipment (receiver and antenna) used for PBM and far-field integrity monitoring (FFM) should be of high quality (geodetic receiver and antenna). It is of special relevance that the antenna has multipath reduction capability.
- **Location of the installed antenna for PBM** (away from possible local interference effects) is crucial to achieve a good system performance.

Notwithstanding, particular recommendations for IALA beacons, AIS and communications have been derived from the execution of the pilot projects and are presented below.

### Recommendations for IALA beacons implementation:

When broadcasting **corrections through IALA beacons**, authorities should take into account the following recommendation:

- In case a communication outage between the central server and the transmitter site occurs, the system should be designed to avoid buffering and retransmitting the old corrections once the communication is resumed. Even though this issue can be identified when using a DGNSS radio-beacon, it can also be made applicable to AIS-based architectures.

### Recommendations for AIS Base stations implementation:

When broadcasting **corrections through AIS**, authorities should take into account:

- Verification that the AIS Base Station can actually **broadcast Message 17**. When planning to use an AIS Base Station as a **FFM**, verification that it can actually **use Message 17 to compute its position**.
- **Ensure the following parameters are properly defined:**
  - Number of slots per message
  - Msg17 slot interval
  - Separation between Msg17 start slots on AIS channels A and B

IALA Recommendation A-124 Appendix 16 provides general recommendations on AIS Message 17 slot settings. However, the actual implementation depends on local circumstances (e.g., location, traffic density, GNSS systems supported, whether AIS base station models in use support single slot reservation to meet 10 seconds TTA or not, etc.). Hence, these parameters should be defined on a case by case basis.

- In order to **minimize impact of transmission of Message Type 17 on other types of information**, the following approach should be followed:
  - As long as there is not an integrity event, other messages can use message 17 slots. However, a minimum update rate of the corrections shall be respected in order to ensure that corrections are provided for all visible satellites and in this way preserve positioning accuracy.
  - A requirement shall be set to guarantee the capability of transmitting a message within the next 3 1/3 seconds upon an event as already stated in IALA Recommendation A-124 Appendix 16. Alternatively, other ways to meet the 10-second TTA requirement should be identified. This question should be revisited within IALA.
  - To avoid collisions between close located AIS stations in countries' border areas, it is recommended to develop a FATDMA plan. The FATDMA is a manually managed TDMA access point scheme where AIS devices are preconfigured to use specific TDMA slots for all transmissions. FATDMA is defined

in ITU-R M.1371-4 Annex 2, and the need of a plan is further details in IALA R-124 Appendix 14 “FATDMA planning and operation of an AIS service”

### **Recommendations to the communication infrastructure:**

In SBAS-based centralized solutions, reliable communication lines are essential to ensure that no data gaps or network outages occur, compromising the availability and continuity figures. This problem is common with other architectures that have similar communications requirements, such as:

- 1) DGNSS radio beacons following the network approach
- 2) AIS base stations that receive corrections via the Internet generated by a DGNSS reference station.

These communication problems can be mitigated by setting Service Level Agreements (SLA) with the communication providers.

However, for those cases where this is not possible (e.g., remote locations located in rural areas) or even when this is possible but to ensure enough redundancy, two alternative solutions can be considered:

- 1) Redundancy of monitoring stations** - With this solution a network of IM stations is distributed in the service area, which will be responsible of:
  - Providing raw data to perform the Pre-Broadcast Integrity checks at the Central Server.
  - Act as Far-Field monitors assessing also the quality of the correction data radio link.
  - Inform service operators in case of problems detected with reference stations.

Furthermore, to ensure stations redundancy, it is possible to use public GNSS networks for this purpose (e.g., EUREF Permanent Network, SAPOS network in Germany) perhaps with a combination of authority-owned sensor stations. This should reduce the deployment and maintenance costs.

- 2) Redundancy of data links** - diversification of data links is also beneficial to ensure that if a data link fails, another link can be available.

Both solutions can be implemented separately or a fair combination of both can also be adopted.